



Office of the Government Chief Information Officer
The Government of the Hong Kong Special Administrative Region

**EFFECTIVE SYSTEMS ANALYSIS AND DESIGN
GUIDE
APPENDIX C
TEMPLATES
[G61c]**

Version: 1.1

December 2016

© The Government of the Hong Kong Special Administrative Region

The contents of this document remain the property of the Office of the Government Chief Information Officer, and may not be reproduced in whole or in part without the expressed permission of the Office of the Government Chief Information Officer

Amendment History				
Change Number	Revision Description	Section Affected	Revision Number	Date
1	As detailed in 1.01 to 1.05. This revision is based on the section 1 “System Analysis and Design Report” of Appendix B in version 1.0 which had been moved to this document as Appendix C in version 1.1.		1.1	December 2016
1.01	Add “Management Summary” section	1 (<i>New</i>)		
1.02	Add “Use Case Specification” template	3.1.3.2		
1.03	Revise the team member in the table of "List of Technical Requirements" under the section "List of Technical Requirement"	3.2.1		
1.04	Remove the metadata field in the table of “Function Definition”	4.1.2.1		
1.05	Add a sample State Diagram in “Design Application” section	4.3.1.1.2		

1 SYSTEM ANALYSIS AND DESIGN REPORT

- (a) The System Analysis and Design (“SA&D”) phase signifies the commencement of system implementation. The objectives of this phase are:
 - i) to investigate and understand the user and technical requirements;
 - ii) to specify and design the new system; and
 - iii) to detail the implementation requirements in terms of cost, effort and time.
- (b) The SA&D Report will be produced to document the findings and recommendations of this phase.
- (c) A sample template of the SA&D Report with sample content is provided in the following pages. B/Ds can adopt the template flexibly and make changes if necessary.
- (d) Notes for using the template are written in “*italic*” text enclosed in pointed brackets “<>”, while sample contents are written in “***bold italic***” and can be replaced by project-specific information or removed to suit specific project needs. After all changes are made, all notes should be removed and font of all “*italic*” text should be changed to black.

With Sample Content

SYSTEM ANALYSIS AND DESIGN REPORT

FOR

PROJECT NAME

OF

DDD DEPARTMENT

Version: X.X.X

MMM YYYY

© The Government of the Hong Kong Special Administrative Region

The contents of this document remain the property of and may not be reproduced in whole or in part without the express permission of the Government of the HKSAR.

Table of Contents

1	MANAGEMENT SUMMARY	1
1.1	APPROVAL SOUGHT	1
1.2	SYSTEM OBJECTIVES.....	1
1.3	BACKGROUND.....	1
1.3.1	Current System Description	1
1.4	PROPOSED SYSTEM.....	2
1.4.1	System Overview	2
1.4.2	System Functions	2
1.4.3	Technical System Architecture	3
1.5	RESOURCE IMPLICATIONS	3
1.6	COSTS AND BENEFITS	4
1.6.1	Costs	4
1.6.2	Benefits.....	4
1.7	IMPLEMENTATION PLAN.....	5
2	CURRENT ENVIRONMENT DESCRIPTION	6
2.1	CURRENT SYSTEM DESCRIPTION.....	6
2.1.1	Current System Overview	6
2.1.2	Current System Hardware, Software and Network	6
2.1.3	Volumes and Frequencies	7
2.1.4	Interface with Other Systems	7
2.2	CURRENT BUSINESS PROCESS	8
2.3	CURRENT PROBLEMS AND ISSUES	9
3	REQUIREMENTS SPECIFICATION.....	10
3.1	USER REQUIREMENTS DOCUMENT	10
3.1.1	Proposed System Overview.....	10
3.1.1.1	Description of Proposed <i>Library Management System</i>	10
3.1.1.2	System User Profile.....	10
3.1.2	Future Business Process	11
3.1.2.1	List of Future Business Processes	11
3.1.2.2	BP-001 Borrow book	11
3.1.2.3	BP-002 Reserve Book	13
3.1.3	Functional Requirements.....	13
3.1.3.1	List of Functional Requirements	13
3.1.3.2	REQ-SYS-001 Login	13
3.1.3.3	REQ-BOR-001 Borrow book.....	14
3.1.3.4	REQ-BOR-002 Check availability.....	14
3.1.4	Non-functional Requirements	15
3.1.4.1	List of Non-functional Requirements.....	15
3.1.4.2	REQ-ACS1 System Audit	15
3.1.4.3	REQ-ACS2 System Control.....	15
3.2	TECHNICAL REQUIREMENTS.....	16
3.2.1	List of Technical Requirements.....	16
3.2.2	TR-SBR-001 Server House Keeping	17
3.2.3	TR-SBR-002 Backup, Recovery and System Archive.....	17
4	SYSTEM SPECIFICATION	18
4.1	FUNCTIONAL SPECIFICATION	18
4.1.1	Required System Overview	18

With Sample Content

4.1.2	Function Definition	18
4.1.2.1	UF-0001 Borrow book	19
4.1.2.2	UF-0002 Check availability	20
4.2	ARCHITECTURE DESIGN	21
4.2.1	Application Architecture	21
4.2.1.1	Application	21
4.2.1.2	Security.....	23
4.2.1.3	Integration	24
4.2.2	Data Architecture.....	25
4.2.2.1	Data Source	25
4.2.2.2	Data Store Architecture	25
4.2.2.3	Data Retention and Archive	26
4.2.2.4	Data Conversion Architecture	26
4.3	SYSTEM DESIGN.....	28
4.3.1	Application	28
4.3.1.1	Design Application	29
4.3.1.2	Design Integration	35
4.3.1.3	Design Data Conversion.....	35
4.3.1.4	User Experience Design	36
4.3.2	Data Model	39
4.3.2.1	Logical Data Model.....	39
4.3.2.2	Physical Data Model	40
5	TECHNICAL SYSTEM OPTION	42
5.1	TECHNICAL SYSTEM ARCHITECTURE	42
5.1.1	Network Architecture	42
5.1.2	Storage Architecture	43
5.1.3	Platform Architecture	43
5.2	SIZING MODEL.....	44
5.3	COST / BENEFIT EVALUATION	48
5.4	IMPACT ANALYSIS	49
5.5	IMPLEMENTATION PLAN.....	52

1 MANAGEMENT SUMMARY (NEWLY ADDED SECTION)

1.1 APPROVAL SOUGHT

Sample:

Approval is sought to endorse the System Analysis and Design (SA&D) report and to proceed to the Stage of System Implementation and Integration of the project. This report is compiled as a result of the SA&D Study of the Library Management System for the XXX Bureau/Department of the Government of the Hong Kong Special Administrative Region (HKSARG) (the Government)...

1.2 SYSTEM OBJECTIVES

<Describe briefly the purpose of the project.>

Sample:

The main objectives of this project are to:

- *streamline the operation of the current library system.*
- *enhance the system architecture and the interoperability ...*

1.3 BACKGROUND

<Describe the business-related reason for initiating the project and the system requests to solve the problem or to achieve any objective according to the business needs of stakeholders.>

Sample:

In the Government, library management functions are mostly practised in manual ways with the aid of various computer systems. For those libraries that implemented individual systems to streamline their workflow, the systems are typically used for keeping records ...

1.3.1 Current System Description

<Include brief description of the current systems information.>

Sample:

The current system allows Users to borrow books, who must first manually search if there are any available stocks. The User then must display their library card to a Librarian, who will then issue the book...

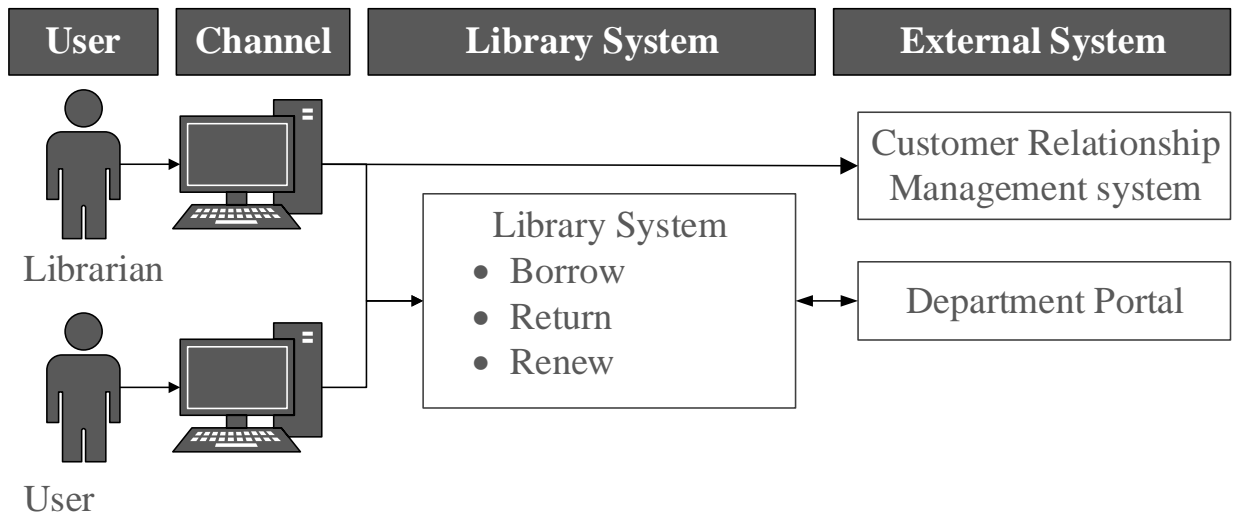

1.4 PROPOSED SYSTEM

<Describe the basic information of proposed system functions which can deliver value to the business needs according to the collected system requirements.>

1.4.1 System Overview

Sample:

The proposed IT system will enable Users to sign into the library system using their mobile application, and where they can search for their desired book and immediately see if there is any stock available. If the book is available and not reserved, and the User has no outstanding fines, the librarian will issue the book to the User...

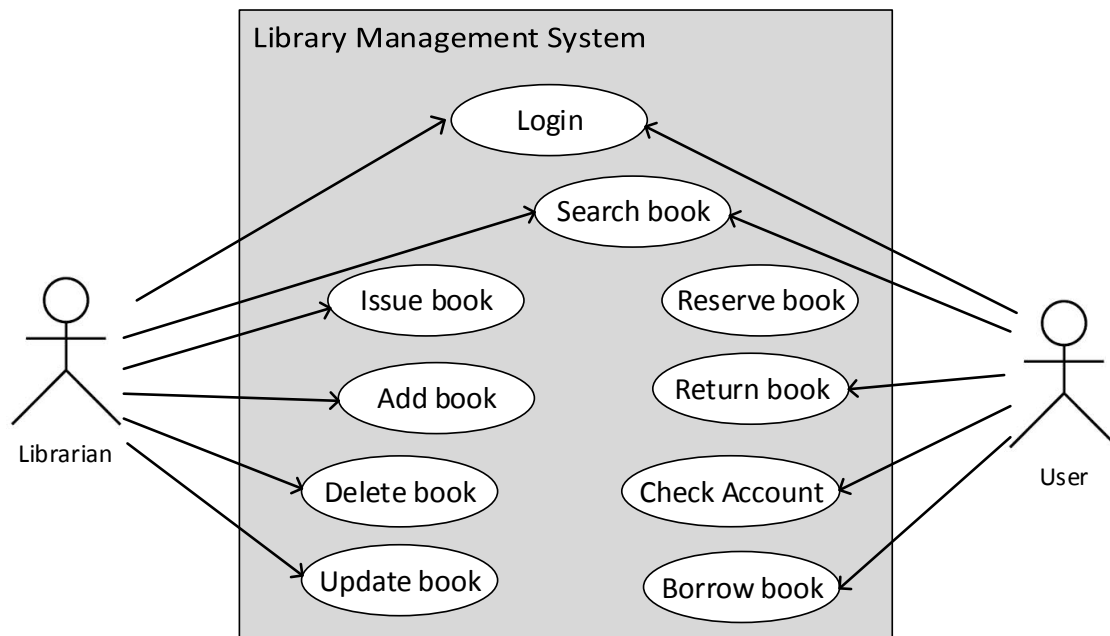

1.4.2 System Functions

Sample:

The proposed system will cover the following major function areas:

Item	System Functions
1	<u>Common requirements for Library Management System</u>
1.1	<i>The general functional requirements for features in the Library System which includes...</i>
2	<u>Book Management System</u>
2.1	<i>Book record maintenance</i>
2.2	<i>House Keeping</i>
3	<u>Borrow Book System</u>
3.1	...

1.4.3 Technical System Architecture

Sample:

The system will reside at a virtual environment under the Central Computer Centre Virtualized Infrastructure (CCCVI) which is supported by the Office of the Government Chief Information Officer (OGCIO) operation team, and will make use of the existing components of...

1.5 RESOURCE IMPLICATIONS

<Describe the resource required including staff effort in term of man-days or cost.>

Sample:

The estimated staff resources required in man-days to develop the system and to provide ongoing system maintenance are summarized below:

Detailed breakdown for System Implementation & Integration (SI&I) services in man-days:

Stage	Program Manager	Business Analyst	System Analyst	Analyst Programmer	UX Designer
<i>Stage 2 - Physical Design and Program Development</i>	<i>30</i>	<i>60</i>	<i>80</i>	<i>120</i>	<i>30</i>
<i>Stage 3 - Acceptance Testing</i>	<i>10</i>	<i>30</i>	<i>60</i>	<i>30</i>	<i>10</i>
<i>Stage 4 - Data Conversion</i>	<i>10</i>	<i>10</i>	<i>30</i>	<i>60</i>	<i>0</i>
<i>Stage 5 - Documentation and Rollout</i>	<i>20</i>	<i>20</i>	<i>80</i>	<i>80</i>	<i>0</i>
<i>Stage 6 - Nursing</i>	<i>5</i>	<i>0</i>	<i>10</i>	<i>10</i>	<i>0</i>
<i>Stage 7 - ...</i>	<i>5</i>	<i>...</i>	<i>...</i>	<i>...</i>	<i>...</i>
<i>Total</i>	<i>80</i>	<i>...</i>	<i>...</i>	<i>...</i>	<i>...</i>

Detailed breakdown for annual System Maintenance & Support (SM&S) services in man-days:

Stage	Program Manager	Business Analyst	System Analyst	Analyst Programmer	UX Designer
<i>System Maintenance & Support Service</i>	<i>10</i>	<i>10</i>	<i>65</i>	<i>133</i>	<i>0</i>
...	<i>5</i>
<i>Total</i>	<i>15</i>

1.6 COSTS AND BENEFITS

1.6.1 Costs

<List the non-recurrent cost and annual recurrent cost of the project including the staff effort and hardware/software/service required.>

Sample:

For implementation of the Library Management System, the estimated total non-recurrent and annual recurrent costs are HK\$11,880,000 and HK\$1,798,000 respectively.

Non-Recurrent Cost	Cost (HK\$'000)
<i>Hardware & Software</i>	<i>2,000</i>
<i>Service implementation</i>	<i>X,XXX</i>
<i>IT-Staff</i>	<i>X,XXX</i>
<i>Total</i>	<i>XX,XXX</i>

Annual Recurrent Cost	Cost (HK\$'000)
<i>Hardware & Software</i>	<i>400</i>
<i>Service implementation</i>	<i>XXX</i>
<i>IT-Staff</i>	<i>XXX</i>
<i>Total</i>	<i>X,XXX</i>

1.6.2 Benefits

<Describe the business value of the system which can benefit the organization.>

Tangible Benefits

The system is contributed to achieving the following benefits:

- *Library Management System helps the library lower the cost of daily operation and services.*
- *With Library Management System, there is no need to acquire servers and equipment for individual installation and hence the maintenance costs of hardware can be greatly reduced.*
- *Library can adopt the system by contributing one-off adoption cost for...*
- ...

Moreover, each library can subscribe the desired function modules as required and ...

Intangible Benefits

Library Management System will adopt the cloud technology and service-oriented architecture which allow the data/system functions to be conveniently shared across different libraries. In this way, the deployment lead-time is largely improved and benefits can be realized more quickly...

1.7 IMPLEMENTATION PLAN

<List the work plan for the project according to the selected development approach, time frame and estimated effort required.>

Sample:

The production launch of Library Management System will take place in December 2016. The major activities are tabulated in the following table:

Items	Activity	Start Date	End Date
<i>1</i>	<i>Setup of Development Environment</i>	<i>Jan 2016</i>	<i>Jan 2016</i>
<i>2</i>	<i>Business Process Re-engineering Study</i>	<i>Feb 2016</i>	<i>Mar 2016</i>
<i>3</i>	<i>System Analysis and Design</i>	<i>XXX 2016</i>	<i>XXX 2016</i>
<i>4</i>	<i>System Development</i>	<i>XXX 2016</i>	<i>XXX 2016</i>
<i>5</i>	<i>System Integration Test</i>	<i>XXX 2016</i>	<i>XXX 2016</i>
<i>6</i>	<i>User Acceptance Test</i>	<i>XXX 2016</i>	<i>XXX 2016</i>
<i>7</i>	<i>User Training</i>	<i>XXX 2016</i>	<i>XXX 2016</i>
<i>8</i>	<i>Security Risk Assessment and Audit</i>	<i>XXX 2016</i>	<i>XXX 2016</i>
<i>9</i>	<i>System Documentation</i>	<i>XXX 2016</i>	<i>XXX 2016</i>
<i>...</i>	<i>...</i>	<i>...</i>	<i>...</i>
<i>...</i>	<i>Production Launch</i>		
<i>...</i>	<i>Nursing</i>	<i>XXX 2016</i>	<i>XXX 2016</i>

2 CURRENT ENVIRONMENT DESCRIPTION

2.1 CURRENT SYSTEM DESCRIPTION

<Include brief description of the current systems information.>

Sample:

The current system allows Users to borrow books, who must first manually search if there are any available stocks. The User then must display their library card to a Librarian, who will then issue the book...

2.1.1 Current System Overview

<Include a high level diagram showing the interactions between the system and the user, as well as any interfaces or interactions between the system and external systems/parties.>

<Diagram for high level system overview.>

Sample:

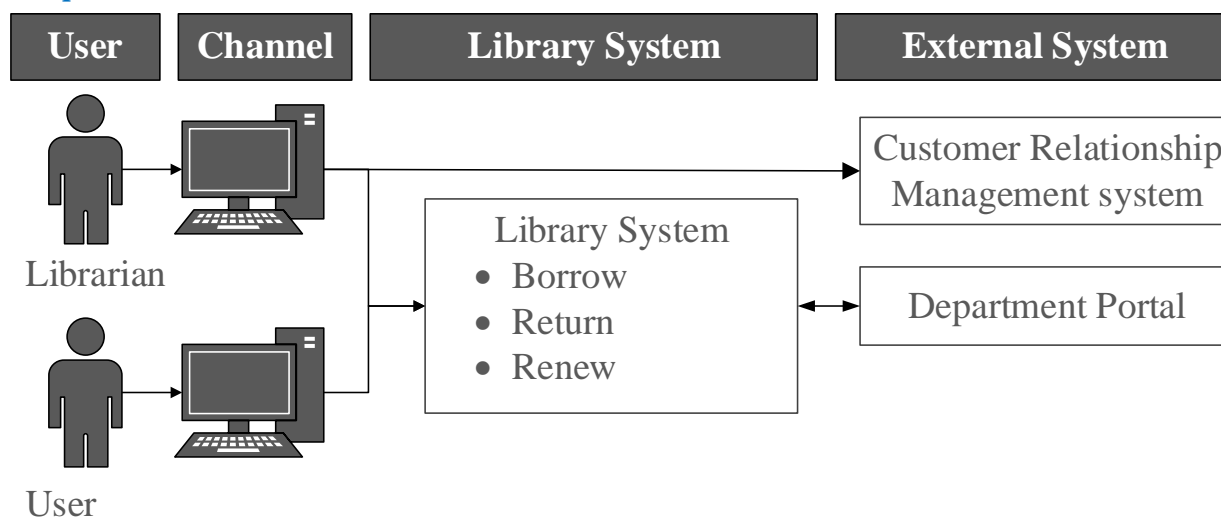

High level system overview:

Subsystem	Function
<List the subsystems>	<List the functions>
<i>Library system</i>	<ul style="list-style-type: none"> <i>Borrow</i> <i>Renew</i> <i>Return</i>

2.1.2 Current System Hardware, Software and Network

<Describe the current system's hardware and software configuration.>

System hardware:

Hardware	<i>Application Server</i>
Server Name	<i>APP_SVR_1</i>
CPU	<i>Intel® Xeon® Processor E5-2687W</i>
Memory	<i>64GB RAM</i>
Hard Disk Storage	<i>8x300GB SAS HDD</i>

System software:

Software	<i>Application Server</i>
<i>Operating System</i>	<i>Windows Server 2012 R2</i>
<i>Application Server Software</i>	<i>IBM WebSphere Application Server 8.5</i>
<i>Backup Software</i>	<i>CA Arcserve Backup V16</i>

<This section contains the high level system network diagram and its descriptions.>

<High level system network diagram.>

Sample:

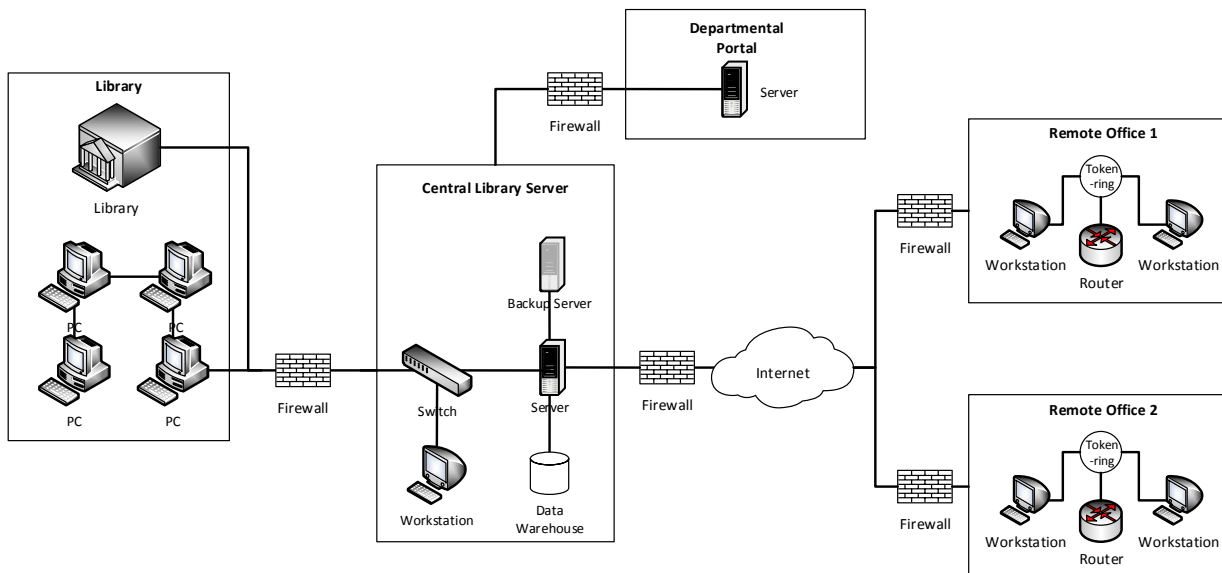

2.1.3 Volumes and Frequencies

<Summarise the data volumes and frequencies of processes of the current system.>

Data volume and frequencies:

Subsystem	Description	Volume and Frequencies
<List the subsystems>	<Description of the subsystems>	<Description>
<i>Library system</i>	<i>Borrow, Renew and Return</i>	<i>9000 transactions per day</i>

2.1.4 Interface with Other Systems

<Describe any current system interfaces.>

System interfaces:

Interface	External Parties	Description
<List the interface>	<List the parties>	<Description>
<i>Departmental Portal</i>	<i>OGCIO</i>	<i>1. User authentication for system access 2. Passing the B/D code, user ID, rank code for validation.</i>

2.2 CURRENT BUSINESS PROCESS

<Include the model of current business process and follow by a table/paragraph to elaborate the process if needed. Typically, the major elements that need to be captured in the Process Diagrams are:

- *Event*
 - *Denote something that happens*
- *Activity*
 - *Describe the kind of work that needs to be performed*
- *Gateway*
 - *Describe the decision factors and determines where the next step should go*
- *Connections*
 - *Describe how the process flow objects are connected.>*

<User type as well as the system / process boundary can also be included in a swim lane diagram. A complex business process can be broken down into sub-level if needed.>

<Business process diagram(s).>

Sample:

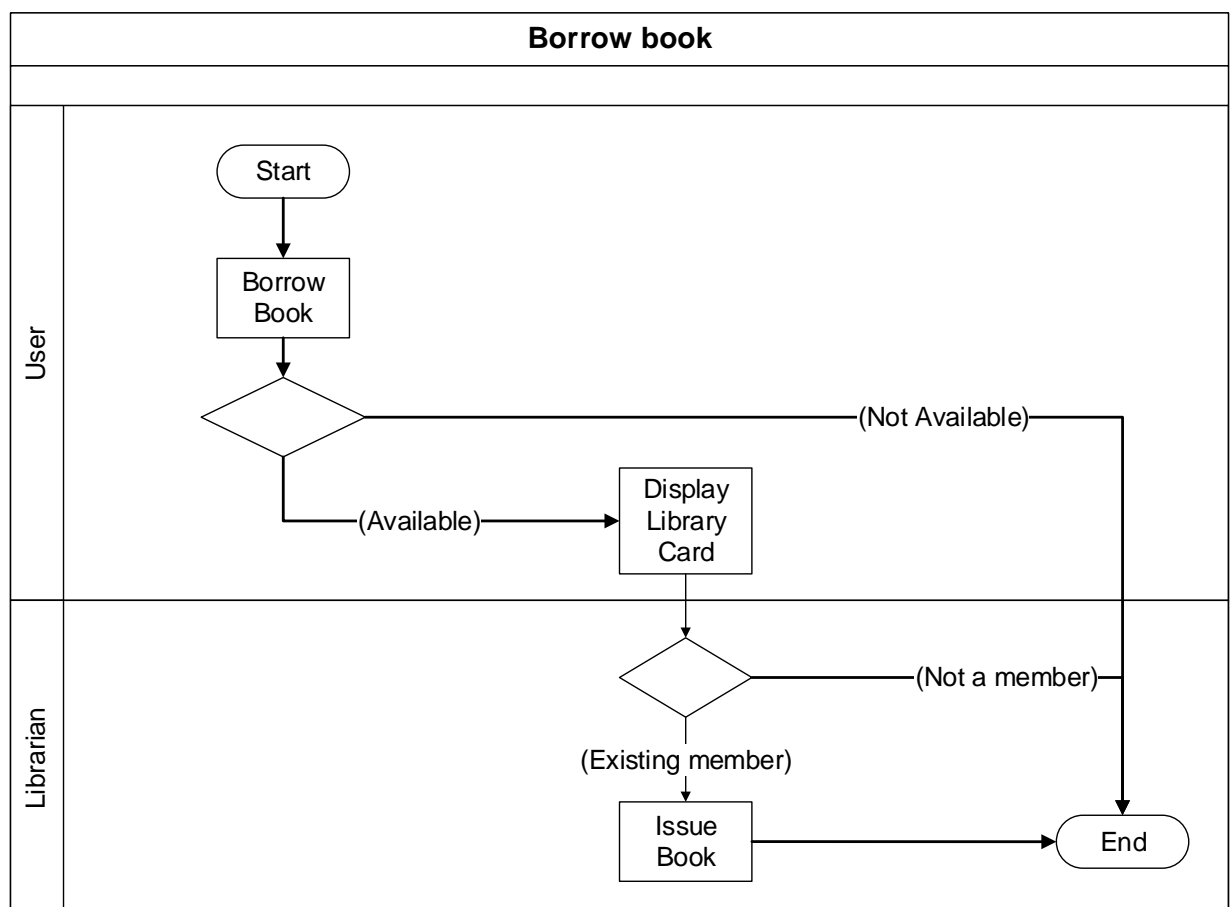

2.3 CURRENT PROBLEMS AND ISSUES

<Provide the problems and issues encountered by the business or IT currently.>

Problems and issues:

No.	Description
<i><Unique number></i>	<i><Description></i>
<i>1</i>	<i>User must be able to display their Library Member Card to Librarian before having the book issued to them.</i>
<i>2</i>	<i>Current system does not support e-book...</i>

3 REQUIREMENTS SPECIFICATION

3.1 USER REQUIREMENTS DOCUMENT

3.1.1 Proposed System Overview

<This section provides a brief description about the proposed IT system to be developed by presenting a high-level conceptual model of the system and showing a system user profile about the users of the proposed IT system that will be referred to in following sections.>

Sample:

The proposed IT system will enable Users to sign into the library system using their mobile application, and where they can search for their desired book and immediately see if there is any stock available. If the book is available and not reserved, and the User has no outstanding fines, the librarian will issue the book to the User...

3.1.1.1 Description of Proposed Library Management System

<Include an overview of the whole business function.>

<Diagram for overview of the whole business function.>

Sample:

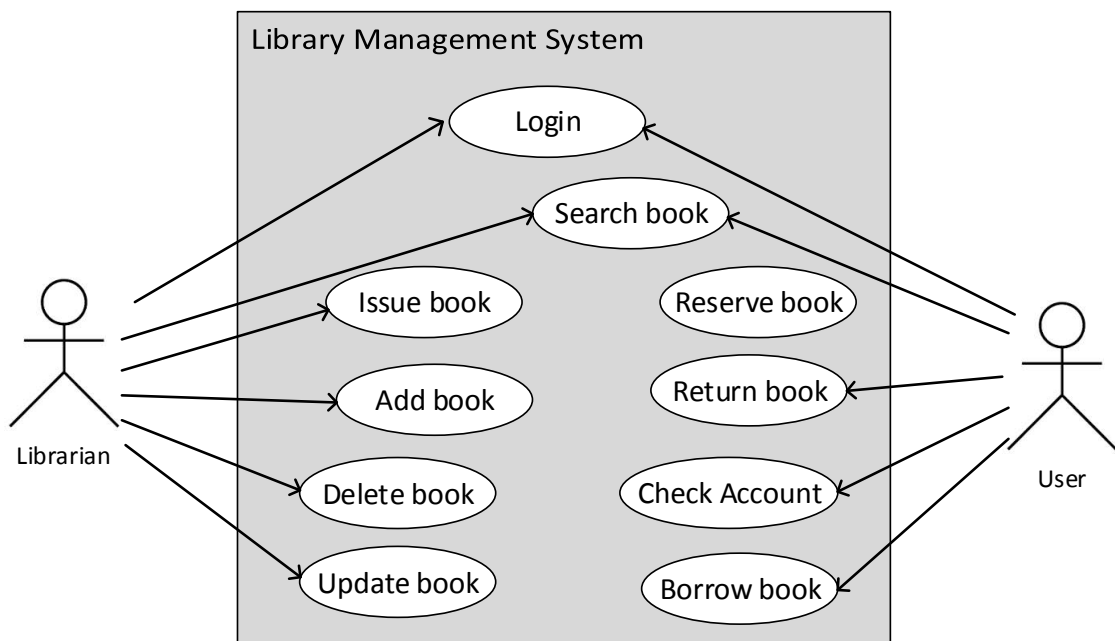

3.1.1.2 System User Profile

<The following provides a table of external and internal users of the proposed IT system. Each user will have a role in the proposed IT system as shown in the circles in the above context diagram, and mapped to a user type in the table below.>

System User Profile:

No.	User Role	Responsibilities	Branch/ Division/ Section/ Unit	Staff Post/Rank	Stakeholder Group
1	Librarian	Responsible for overseeing the entire	Administration	Librarian	Library stakeholders

No.	User Role	Responsibilities	Branch/ Division/ Section/ Unit	Staff Post/Rank	Stakeholder Group
		<i>system's operation and use</i>			
2	XX	<i>Responsible for xx</i>	<i>XX Section</i>	<i>XX or equivalent ranks</i>	<i>Library stakeholders</i>
3	XX	<i>Responsible for xx</i>	<i>XX Section</i>	<i>XX or equivalent ranks</i>	<i>Library stakeholders</i>

3.1.2 Future Business Process

<For each future business process, include a separate business process diagram. Provide an overview of functional requirements. For complex business process, breakdown the process into smaller processes, each with a separate diagram.>

3.1.2.1 List of Future Business Processes

<The following table provides a list of future business process flows for the system.>

List of Future Business Processes:

Process ID	Business Process Title
<i>BP-001</i>	<i>Borrow book</i>
<i>BP-002</i>	<i>Reserve book</i>
<i>BP-003</i>	<i>Return book</i>
<i>BP-004</i>	<i>Search book</i>

3.1.2.2 BP-001 Borrow book

<Diagram(s) for future business processes.>

Sample:

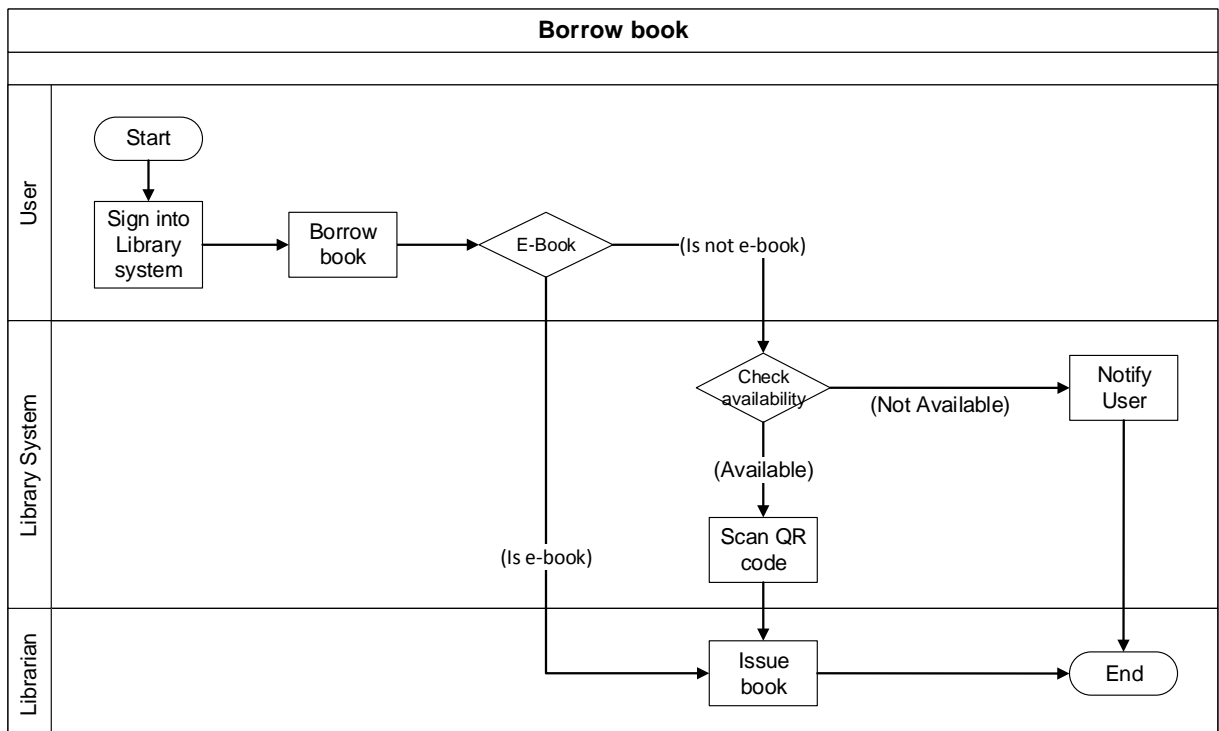

<The major elements that need to be captured in the Process Diagrams are:

- *Event*
 - *Denote something that happens*
- *Activity*
 - *Describe the kind of work that needs to be performed*
- *Gateway*
 - *Describe the decision factors and determines where the next step should go*
- *Connections*
 - *Describe how the process flow objects are connected >*

Narratives:

Task No.	Actor	Task Name and Description	Input	Output
<Input the task no.>	<Input actor>	<Input task name and description>	<Input>	<Output>
<i>1</i>	<i>User</i>	<i>Sign into Library system – User signs into Library system without need to display library card to Librarian</i>	<i>Task step: Provide library card number and password</i>	<i>Task step: Access Library system</i>
<i>2</i>	<i>User</i>	<i>Borrow book - User enters requests to borrow a book into Library system</i>	<i>Task step: Borrow book</i>	<i>Task step: Check availability</i>
<i>3</i>	<i>Library System</i>	<i>Check availability - Check if book has been reserved or is being borrowed in system records</i>	<i>Task step: Issue book</i>	<i>Task step: Locate book and distribute to User</i>

Other information:

Glossary
References
<Input references>
<i>N/A</i>
Assumptions:
<Input assumption>
<ol style="list-style-type: none"> <i>1. It is assumed that the Librarian can access the Departmental Portal to fulfill their tasks.</i> <i>2. It is assumed that the User is in possession of their library card number and password to sign into the library system.</i> <i>3. E-book can only be viewed inside the library.</i>
Business Rules
<Input business rules>
<ol style="list-style-type: none"> <i>1. Library system cannot give approval to Librarian if book is reserved by another User.</i> <i>2. A book can be reserved by a maximum of 3 people at any particular time.</i> <i>3. Any outstanding fines the User must have been paid in full before he/she is allowed to borrow any books.</i>

3.1.2.3 BP-002 Reserve Book

<Diagram(s) for future business processes.>

...

3.1.3 Functional Requirements

<State the Functional Requirements in this section in numbered tables or paragraphs by grouping them according to business nature or types of requirements and assigned with a unique requirement number, e.g. REQ- CRE-000, 001, 002, 003, etc. for ease of reference.>

3.1.3.1 List of Functional Requirements

<All functional requirements of the proposed IT system should be listed in the following table and then explained in detail one by one. Each requirement is assigned with a priority to indicate its importance, e.g. MUST (M), SHOULD (S), COULD (C) and WON'T (W). B/Ds may assign priorities using other ranking, e.g. High, Medium and Low.>

List of Functional Requirements:

Req. ID	Requirement Title	Target Users	Priority
<i>REQ-SYS-001</i>	<i>Login</i>	<i>User/Librarian</i>	<i>M</i>
...
<i>REQ-BOR-001</i>	<i>Borrow book</i>	<i>User</i>	<i>M</i>
<i>REQ-BOR-002</i>	<i>Check availability</i>	<i>User</i>	<i>M</i>
<i>REQ-BOR-003</i>	<i>Notify User</i>	<i>User</i>	<i>M</i>
...

3.1.3.2 REQ-SYS-001 Login (Newly Added Section)

User case specification:

Use Case ID:	<i>UC01</i>		
Use Case Name:	<i>Login</i>	Version No:	<i>01.002</i>
Purpose:	<i>User/Librarian login the system</i>		
Last Update by:	<i>Hamilton</i>	On (date):	<i>04 April 2016</i>
Approved by:	<i>Vettel</i>	On (date):	<i>05 April 2016</i>
User/Actor:	<i>User/Librarian</i>		
Business Owner Name:	<i>Alonso</i>		
Trigger:	<i>User or Librarian access the system protected login page</i>		
References:	<i>N/A</i>		
Frequency of Use:	<i>Daily</i>		
Volume of Use	<i>N/A</i>		
Preconditions:	<i>N/A</i>		
Post Conditions:	<i>N/A</i>		

Non-functional Requirements	<i>N/A</i>		
Assumptions:	<i>N/A</i>		
Business Rules:	<i>N/A</i>		
Main Flow 1			
Step	Actor	Description	Alternate/Exception Flow
1	<i>User/Librarian</i>	<i>enters the ID and password</i>	
2		<i>Process the authentication: if the ID and password are correct, the system authenticates the user and displays the relevant functions page. The use case ends.</i>	
3		<i>if any or both of ID and password is/are invalid, the system directs user/librarian to alternate flow #1.1</i>	<i>#1.1</i>
Alternate/Exception Flow	<i>Alternate Flow#1.1</i>		
Step	Actor	Description	Alternate /Exception Flow
1		<i>The system prompts the error message. The use case ends</i>	

3.1.3.3 REQ-BOR-001 Borrow book

Requirements Description:

Item	Description
<i>Requirement ID</i>	<i>REQ-BOR-001</i>
<i>Requirement Title</i>	<i>User selects book to borrow from library online</i>
<i>Priority</i>	<i>Must</i>
<i>Functional Requirement Description</i>	<ul style="list-style-type: none"> • <i>The User shall be able to create a request for borrowing a book in the library system after signing into the Library system.</i> • <i>If a book is wrongly selected, a remove option should be provided for removal of the wrongly selected book.</i> • <i>...</i>
<i>Frequency of Use</i>	<i>Daily</i>
<i>Acceptance Criteria</i>	<i>Same User ID must only select up to 3 books to borrow.</i>
<i>Related Business Process</i>	<i>Refer to BP-001.</i>

3.1.3.4 REQ-BOR-002 Check availability

Requirements Description:

...

3.1.4 Non-functional Requirements

<State the Non-Functional Requirements for the non-functional features such as audit, control and security, global business rules, data requirements, usability requirements, service level targets, user volume and equipment requirements, data growth and retention requirements, etc. that the proposed IT system must possess from a business perspective. The following proposed non-functional requirements can be changed or removed to suit project needs.>

3.1.4.1 List of Non-functional Requirements

<Provide a list of non-functional requirements.>

List of Non-functional Requirements:

Req. ID	Category	Requirement Title	Target Users	Priority
<i>REQ-ACS1</i>	<i>Audit , Control & Security</i>	<i>System Audit</i>	<i>Librarian</i>	<i>M</i>
<i>REQ-ACS2</i>	<i>Audit , Control & Security</i>	<i>System Control</i>	<i>Librarian</i>	<i>M</i>
<i>REQ-ACS3</i>	<i>Audit , Control & Security</i>	<i>System Security</i>	<i>Librarian</i>	<i>M</i>
<i>REQ-ACS4</i>	<i>Audit , Control & Security</i>	<i>Backup and Recovery Requirements</i>	<i>Asst. Librarian</i>	<i>M</i>
<i>REQ-ACS5</i>	<i>Audit , Control & Security</i>	<i>Disaster Recovery Requirements</i>	<i>Asst. Librarian</i>	<i>M</i>
<i>REQ-GBR1</i>	<i>Global Business Rules</i>	<i>Global Business Rules</i>	<i>Librarian</i>	<i>M</i>
<i>REQ-DAR1</i>	<i>Data Requirements</i>	<i>Key Data Requirements</i>	<i>Librarian</i>	<i>M</i>
<i>REQ-USR1</i>	<i>Usability</i>	<i>General Usability Requirements</i>	<i>Librarian</i>	<i>M</i>
<i>REQ-SLT1</i>	<i>Service Level Targets</i>	<i>System Availability</i>	<i>Asst. Librarian</i>	<i>M</i>
<i>REQ-SLT2</i>	<i>Service Level Targets</i>	<i>System Performance</i>	<i>Asst. Librarian</i>	<i>M</i>
<i>REQ-DGR1</i>	<i>Data Growth and Retention Requirements</i>	<i>Data Growth and Retention Requirements</i>	<i>Asst. Librarian</i>	<i>M</i>
<i>REQ-UER1</i>	<i>Number of Users & IT Equipment Requirement</i>	<i>Number of Users & IT Equipment Requirement</i>	<i>Asst. Librarian</i>	<i>M</i>

3.1.4.2 REQ-ACS1 System Audit

Requirements Description:

Item	Description
<i>Requirement ID</i>	<i>REQ-ACS3</i>
<i>Category</i>	<i>Audit , Control & Security</i>
<i>Requirement title</i>	<i>System Security</i>
<i>Priority</i>	<i>Must (except for those specially specified)</i>
<i>Non-functional requirement description</i>	<i>1. All user passwords must not be displayed on screen during user input. All security patches should be properly tested before installed to all system software/programs before production roll out. ...</i>

3.1.4.3 REQ-ACS2 System Control

Requirements Description:

....

3.2 TECHNICAL REQUIREMENTS

<State the Technical Requirements in this section in numbered tables or paragraphs by grouping them according to the type of requirement and assigned with a unique requirement number, e.g. TR-SBR-000, 001, 002, 003, etc. for ease of reference.>

3.2.1 List of Technical Requirements

<Provide a list of technical requirements. The technical requirements supplement the non-functional requirements and are not raised by the Business Analyst, but from the IT project member(s) who raise(s) the technical requirements and is/are responsible for the acceptance of the requirements in UAT.>

List of Technical Requirements:

Req. ID	Requirement Title	Priority	Category	Responsible Team Member(s)
<i>TR-SBR-001</i>	<i>Server House Keeping</i>	<i>M</i>	<i>System Backup and Recovery Requirements</i>	<i>Systems Analyst(s)/Project Manager(s)</i>
<i>TR-SBR-002</i>	<i>Backup, Recovery and System Archive</i>	<i>M</i>	<i>System Backup and Recovery Requirements</i>	<i>Systems Analyst(s)/Project Manager(s)</i>
<i>TR-QRC-001</i>	<i>QR Code Standards</i>	<i>M</i>	<i>QR Code requirements to follow ISO/IEC 18004:2006 standards</i>	<i>Systems Analyst(s)/Project Manager(s)</i>
<i>TR-DRR-001</i>	<i>....</i>	<i>....</i>	<i>Disaster Recovery Requirements</i>	<i>....</i>

<The elements to be captured and documented for the Technical Requirements are:

- *Requirement ID*
 - *Specify a unique ID for each requirement entry.*
- *Requirement Title*
 - *Title for the technical requirement.*
- *Priority*
 - *State the priority of the non-functional requirement, e.g. “Must”, “Should”, “Could” and “Won’t” or other ranking scheme e.g. “essential”, “beneficial if cost justified”, “subsequent enhancement”.*
 - *Possibly have more level of classifications depending on the project situation*
- *Technical Requirements Description*
 - *Describe the technical requirement of the system, i.e., “how” the system should work.*
- *Category (Examples)*
 - *System Backup and Recovery Requirements*
 - *Backup arrangements*
 - *Recovery procedures requirement under various system failures*
 - *Disaster Recovery Requirements*
 - *Minimum service level under disaster*
 - *Off-site backup arrangement*

- *Recovery procedure*
 - *Time required to recover upon disaster*
- *Privacy Requirements*
 - *Protection of personal data from unauthorised disclosure e.g. protection on personal identification document number.*
- *Technical Support Requirements*
 - *Software and hardware support levels*
 - *Equipment maintenance and repair cycles*
 - *Test/diagnostic equipment*
- *Interface Requirements*
 - *User groups*
 - *Content presentation*
 - *Application navigation*
- *Maintainability, Control and System Management Requirements*
 - *System failure(s)*
 - *Operational readiness and success*
 - *System effectiveness evaluation and improvement*
- *Testing*
 - *Design stage testing procedure*
- *Data Conversion*
 - *Data conversion process*
 - *Data cleansing*
 - *Verification program*
- *User Experience*
 - *Overall experience and satisfaction when a user is using a product or system*
 - *Details within the user interface functionality, behaviour, and design*
 - *Industry best practices as part of standard requirements.>*

3.2.2 TR-SBR-001 Server House Keeping

Technical requirements description:

Item	Description
<i>Requirement ID</i>	<i>TR-SBR-001</i>
<i>Requirement title</i>	<i>Server House Keeping</i>
<i>Priority</i>	<i>Low</i>
<i>Category</i>	<i>System Backup and Recovery Requirements</i>
<i>Technical requirement description</i>	<i>System logs must be archived to backup tape weekly</i>

3.2.3 TR-SBR-002 Backup, Recovery and System Archive

Technical requirements description: ...

4 SYSTEM SPECIFICATION

4.1 FUNCTIONAL SPECIFICATION

4.1.1 Required System Overview

<Specify the overview of the targeted system with respect to its features, its relationships and interactions with other systems and components, and its dependencies (if any) on other system functions.>

System overview:

Business Needs	Major Features	System Related Functions
<i>Borrowing book capability</i>	<i>Engine to enable Users to borrow books</i>	<i>Online Book Reserve</i>

4.1.2 Function Definition

<Specify the functions provided by the required system to perform. The major elements that need to be captured in the Function Definition are:

- *Function ID*
 - *Give a unique ID for each function. Project team should decide their own naming convention to suit their project situation. (e.g. RFxxxx for retrieval functions, UFxxxx for update)*
- *Function Name*
 - *Give the name of a function*
- *Component Name*
 - *Describe the logic group of the business function to be implemented*
- *Category*
 - *Categorise the function as presentation layer, operational design consideration, or exception and error handling as specified in the section below*
- *Related Requirements*
 - *List the requirements which are resolved by the function (e.g. Requirements traceability matrix)*
- *Function Description*
 - *Describe briefly the purposes of the function and how it will be used by end users (e.g. the input parameters required)*
- *Mode*
 - *Classify the function as Online/Batch, Enquiry/Update*
- *Frequency*
 - *Specify the minimum, average and maximum frequency in a specified period*
- *Special Service Level Requirements*
 - *Specify the service level required (e.g. response time < 10 seconds), if necessary*

- *Note: General Service Level Requirements have been specified in the Non-functional Requirements section*
- *Business rules (including data validations)*
 - *Describe any business rules for the function*
- *Reports*
 - *Describe the layout of the report, if any*
- *User input screens and forms*
 - *Describe the layout of the screen, if any*
- *Security Requirements*
 - *Describe the identity and access management, user registration, roles based access, privacy requirements, if any>*

<It is also essential to group the system functions into their respective categories, namely presentation layer, operational design consideration, as well as exception and error handling:

- *Presentation Layer*
 - *Categorise the functional design of the system features that are directly visible to the user and with graphical user-interface (GUI) component, such as screen view and field, form and table layout.*
- *Operational Design Consideration*
 - *Categorise essential design considerations that should be kept in mind to ensure smooth operation of the system's functionality, including performance considerations, constraints and dependencies, security and control design, as well as initiation, frequency, and scheduling design.*
- *Exception and Error Handling*
 - *Categorise the system's behaviour when it encounters exception conditions or error scenarios, including exception and errors handled, log output, restart procedures.>*

4.1.2.1 UF-0001 Borrow book

Function definition:

Item	Description
<i>Function ID</i>	<i>UF-0001</i>
<i>Function Name</i>	<i>Borrow book</i>
<i>Category</i>	<i>Presentation Layer</i>
<i>Related Requirements</i>	<i>REQ-BOR-001: Borrow book</i>
<i>Function Description</i>	<i>This function accepts the selected book title from the terminal and retrieves the corresponding book information from the database. Details of book information will be displayed to user.</i>
<i>Mode</i>	<i>Online</i>
<i>Frequency</i>	<i>Daily: Min. (10000) Avg. (20000) Max. (30000)</i>
<i>Special Service Level Requirements</i>	<i>Response time < 10 seconds</i>
<i>Data Integration and Conversions</i>	<i>N/A</i>
<i>Business Rules</i>	<i>If any stock found, then based on the Book Title linked to the reservation records, check if each stock has Any associated reservation</i>

Item	Description																
<i>Reports</i>	<i>No report is required</i>																
<i>User Input Screens and Forms</i>	<p><The screen is illustrated below.></p> <div style="border: 1px solid black; padding: 10px; margin: 10px 0;"> <p>Borrow book</p> <p style="text-align: center;"> <input style="width: 100px;" type="text" value="Keyword"/> <input type="button" value="Search"/> i </p> <table border="1" style="width: 100%; border-collapse: collapse; margin: 10px 0;"> <thead> <tr> <th style="text-align: left; padding: 2px;">Search results</th> <th style="text-align: left; padding: 2px;">ISBN</th> <th style="text-align: left; padding: 2px;">Reserved (Y/N)</th> <th style="text-align: left; padding: 2px;">Select</th> </tr> </thead> <tbody> <tr> <td style="padding: 2px;">Book Title 1</td> <td style="padding: 2px;">XXXXXX</td> <td style="padding: 2px;">Y</td> <td style="padding: 2px; text-align: center;"><input checked="" type="checkbox"/></td> </tr> <tr> <td style="padding: 2px;">Book Title 2</td> <td style="padding: 2px;">XXXXXX</td> <td style="padding: 2px;">N</td> <td style="padding: 2px; text-align: center;"><input type="checkbox"/></td> </tr> <tr> <td style="padding: 2px;">Book Title 3</td> <td style="padding: 2px;">XXXXXX</td> <td style="padding: 2px;">N</td> <td style="padding: 2px; text-align: center;"><input type="checkbox"/></td> </tr> </tbody> </table> <p style="text-align: right; margin-top: 10px;"><input type="button" value="Borrow"/></p> </div>	Search results	ISBN	Reserved (Y/N)	Select	Book Title 1	XXXXXX	Y	<input checked="" type="checkbox"/>	Book Title 2	XXXXXX	N	<input type="checkbox"/>	Book Title 3	XXXXXX	N	<input type="checkbox"/>
Search results	ISBN	Reserved (Y/N)	Select														
Book Title 1	XXXXXX	Y	<input checked="" type="checkbox"/>														
Book Title 2	XXXXXX	N	<input type="checkbox"/>														
Book Title 3	XXXXXX	N	<input type="checkbox"/>														
<i>Security Requirements</i>	<i>N/A</i>																

4.1.2.2 UF-0002 Check availability

Function definition:

....

4.2 ARCHITECTURE DESIGN

<Provide a brief description on the architecture design, including the data and application aspects of the system.>

4.2.1 Application Architecture

<Provide an overview of the content in Application section. Add a high level diagram to depict the overall design of key elements if needed.>

4.2.1.1 Application

<Describe the architecture constraints, e.g. Platform only supports JDK v1.5>

<Describe the layout for application's high level technical solution. Include a visual diagram to illustrate the different layers in the application and their relationship if appropriate.>

<Application Flowchart Diagram.>

Sample:

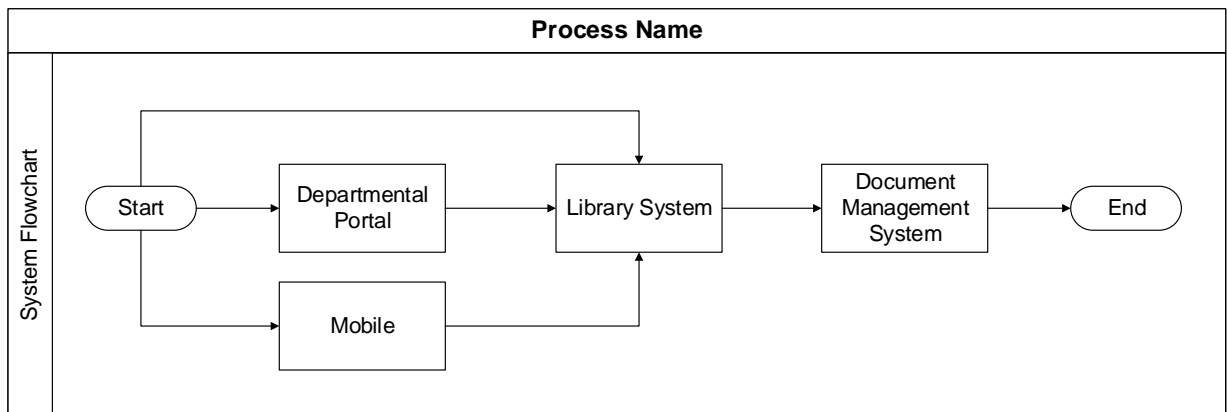

<Divide the application into subsystems that implement the overall application functionality. Describe all the different layers in the application architecture, such as presentation layer, business layer and persistence layer.>

<Application Architecture Block Diagram.>

Sample:

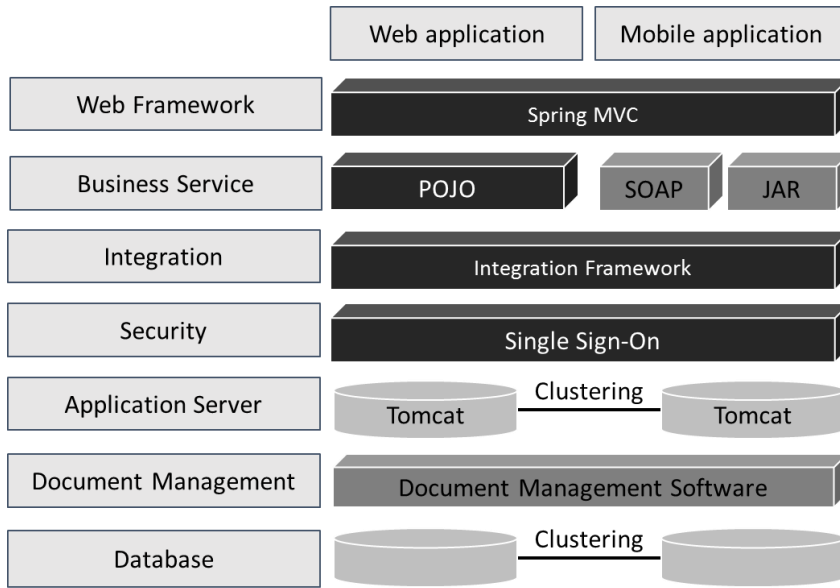

<Deployment Diagram.>

Sample:

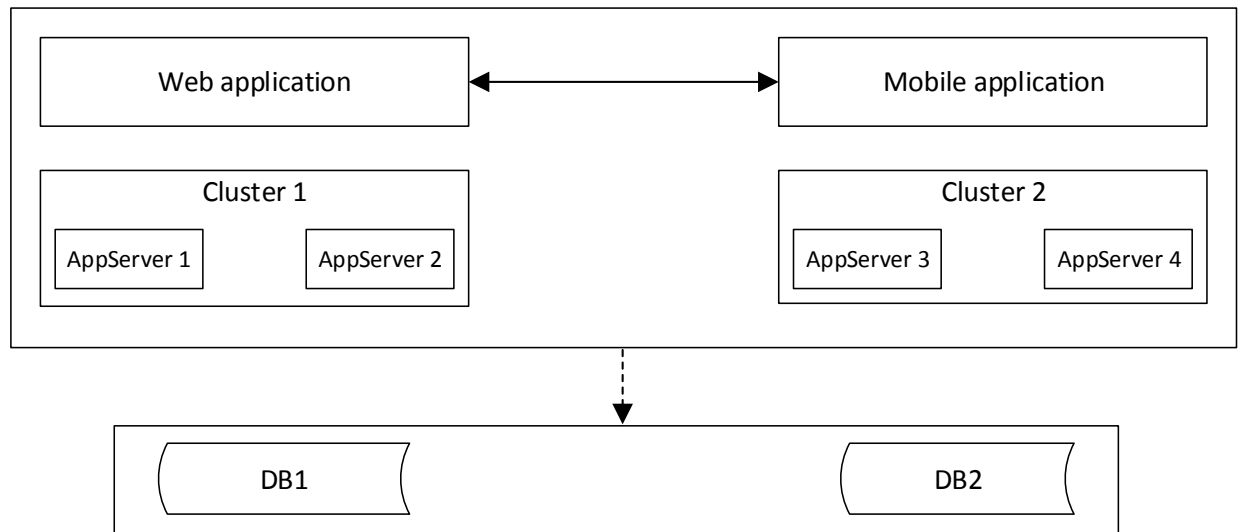

<List the tools and software used for application development, security, integration, and other architecture components to develop the application.>

Tools and software:

Tool / Software	Description	Finalised Tool / Software	Version
<Input the generic name or purpose of the tool or software>	<Input description>	<Input the specific or commercial name of the tool or software>	<Input version number of the tool or software>
<i>Database Synchronisation</i>	<i>Oracle Data to manage all data information</i>	<i>Oracle / Active Data Guard</i>	<i>11g</i>

4.2.1.2 Security

<Describe the high level security components of the core application solution.>

Security components:

Subsystem Name	Data Sensitivity Level	Security Control
<List the subsystems>	<Input sensitivity level>	<Input specification>
<i>Library System</i>	<i>Sensitive</i>	<i>Use database encryption methods – Transparent Data Encryption to encrypt Personally Identifiable Information</i>

<Include the security controls implementation overview diagram which demonstrates where security controls will be implemented based on a user's view.>

<Security controls implementation overview diagram.>

Sample:

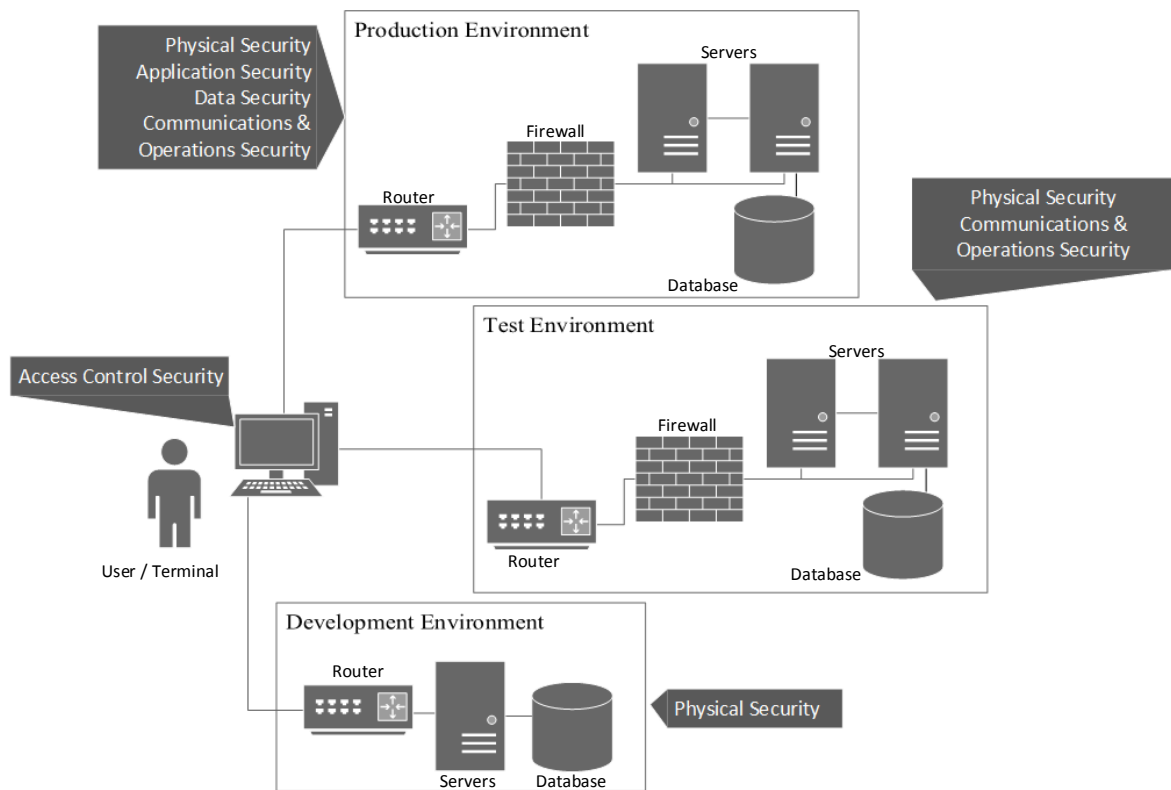

4.2.1.3 Integration

<Describe the design approaches that will be taken for the various integration components of the application, such as web services, messaging, service orchestration, and batch.>

<Application Communication Diagram.>

Sample:

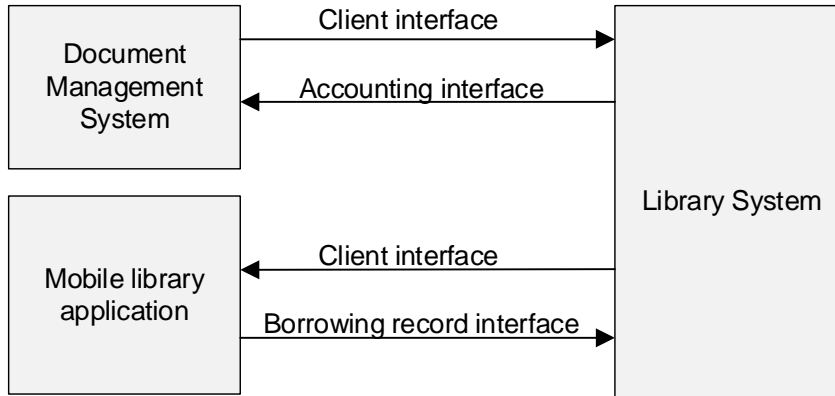

<Provide the necessary details about the deployment of the application.>

<Integration Block diagram.>

Sample:

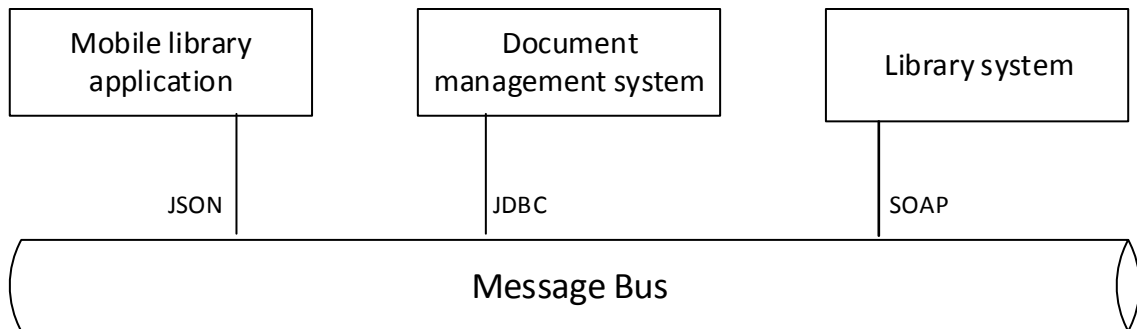

4.2.2 Data Architecture

<Provide an overview of the content in Data section.>

4.2.2.1 Data Source

<Provide a list of data sources required for the data architecture design. Also describe the kind of data in these data sources and frequency of accessing this data.>

Data sources:

Data Source	Description	Type of data	Frequency of access
<i>CRM System</i>	<i>Centralised CRM system of all libraries in Hong Kong</i>	<i>Client Information</i>	<i>Once-off</i>

4.2.2.2 Data Store Architecture

<Describe the core entities, data stores required by the system, the frequency of accessing the data and the flow of data across the different data stores.>

<Provide an overview of the core data entities and relationships which will be ingested and processed by the system.>

<Data storage diagram.>

Sample:



<Conceptual data model diagram.>

Sample:

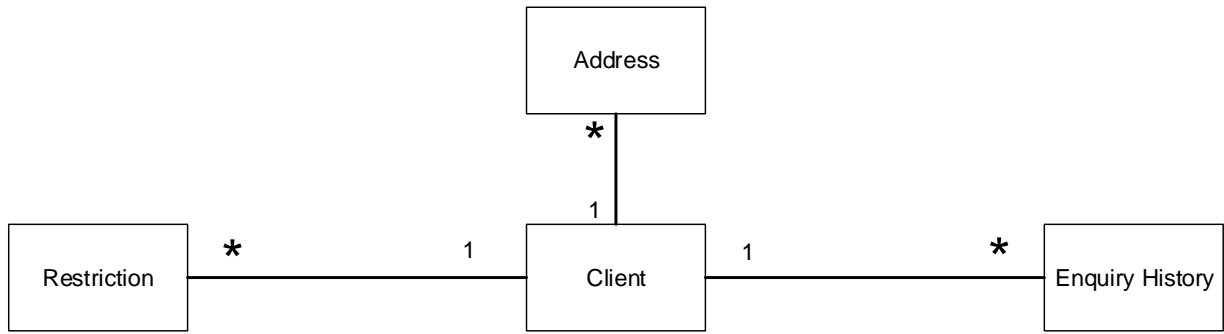

Core data entities:

Entity	Entity Description
<i>Client</i>	<i>Personal information including DOB, HKID, gender</i>
<i>Address</i>	<i>Correspondence / Residential / Work address of Client</i>
...	

4.2.2.3 Data Retention and Archive

<Describe which and how the data are retained and archived. The elements that should be captured.>

Data retention and archive:

Data Element to be retained and archived	Archive Method and Frequency	Data Retention Policy
<i>Client record</i>	<i>Annually</i>	<i>Xx0000_policy_description</i>

4.2.2.4 Data Conversion Architecture

<Identify sources of data to be extracted from one or multiple data stores and loaded into another, or multiple, target data stores and anticipated volume.>

Data conversion:

Data	Source	Target	Anticipated Volume
<Data>	<Input source>	<Input target>	<Input anticipated volume of data>
<i>Client information</i>	<i>e.g. CRM system</i>	<i>Library System Database</i>	<i>10GB</i>

<Define an approach for any data conversion required for a system implementation. A diagram may be created to illustrate the flow of data from the source to the target data stores.>

<Data migration diagram, if appropriate.>

Sample:

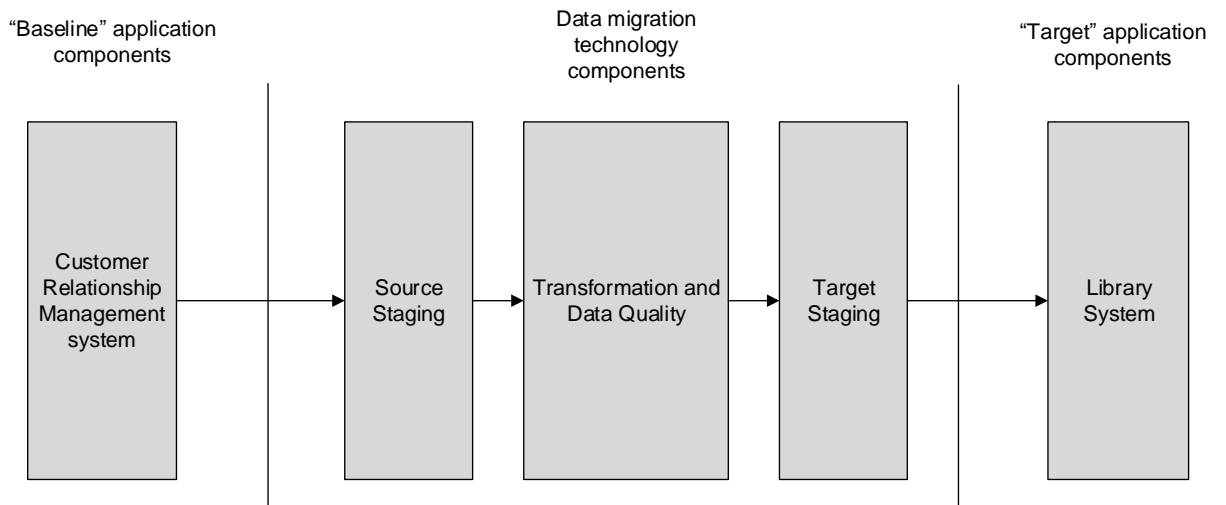

4.3 SYSTEM DESIGN

<Provide an overview of the system design and use a block diagram to depict system diagram if required.>

4.3.1 Application

<Provide an overview of the content in Application section.>

<Class diagram(s).>

Sample:

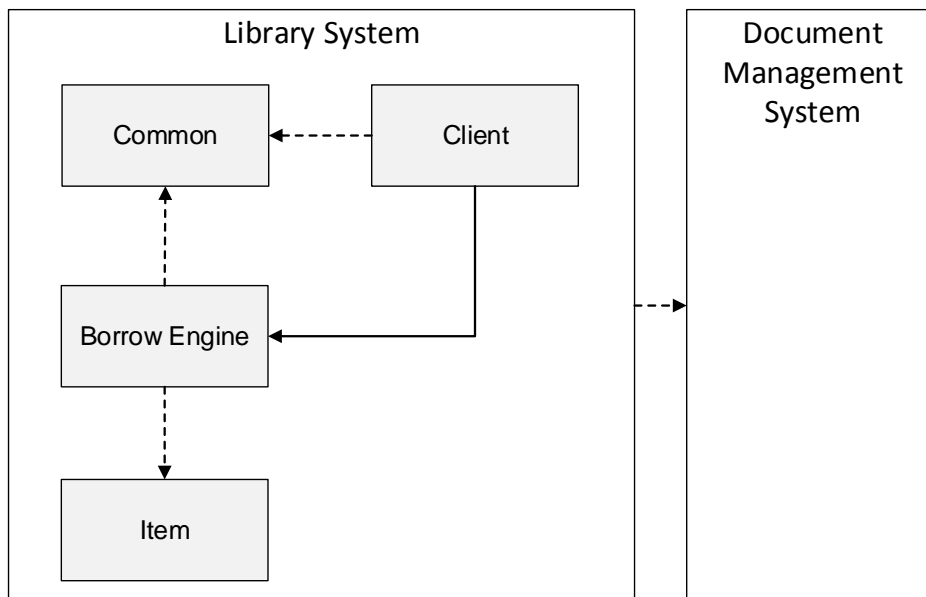

Borrow Engine is a component to manage borrowing book by Client.

4.3.1.1 Design Application

4.3.1.1.1 Describe Common Frameworks

<Class diagram(s).>

Sample:

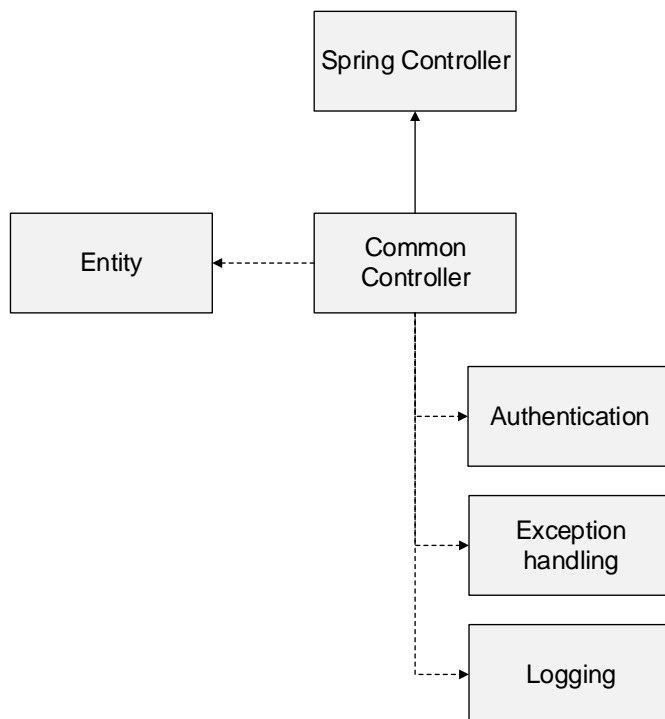

<Identify system components:

- *Security - Assess sensitivities and define security control*
 - *Review the functionality of each subsystem and the corresponding personally identifiable information (e.g., Hong Kong Identity card number) collected, used, stored and shared.*
 - *For each subsystem, define security controls such as identity and access management, database security, network security and business continuity controls.*
 - *Follow existing guidelines to help classify the subsystems and define security controls requirements.*
 - *Develop and document a security controls implementation overview diagram which demonstrates where security controls will be implemented based on a user's view. This will help the user and system owners understand where controls are placed and how data will be protected.*
- *Validation - determine how validations will be performed in the application*
 - *It is recommended that any non-trivial business validations be located in the business services layer instead of the presentation layer. This makes the validation logic available for use by other parts of the application which are not invoked through the UI.*
- *Transaction - The changes on a single entity occurrence as triggered by an event is "effect". The collection of all effects of an event is a transaction, which is either effective completely (i.e., "committed") or cancelled at all (i.e., "rollback").*
- *Logging - define the approach to record and retrieve diagnostic information.*

- *Diagnostic information may include the amount of time needed to execute a critical method, the number of transactions committed per second, or the number of users currently with active sessions.*
- *Exception handling - define the approach to exception handling and how the exception will eventually be handled and logged and how it will be presented to the user.*
 - *In general, the application should support unchecked exceptions. The guiding principle of exception handling in the application is that an exception should only be caught, and similarly a method should only declare a checked exception, if there is some valid response the invoker can make in response to that exception.*
- *Reference table - describe the approach to manage static look-up table or reference table information, such as country list, error messages.*
- *Internationalisation - describe the approach to handle internationalisation of the application. If internationalisation is not necessary, this should be stated. Considerations would include:*
 - *Support for multi-lingual and other internationalised content.*
 - *How database-backed internationalised content will be delivered.*
 - *Support for different character sets.>*

Sample:

Security	<ul style="list-style-type: none"> ● <i>Support two-factor authentication</i> ● <i>HTTPS encryption</i> ● <i>Use parameterised SQL queries</i>
Validation	<ul style="list-style-type: none"> ● <i>Input validation at the presentation layer using validation controls</i> ● <i>Business rule validation logic in domain object</i>
Transaction	<ul style="list-style-type: none"> ● <i>Use multiple active result sets to allow multiple queries to be executed using the same connection</i> ● <i>Implement compensating methods to revert the data store to its previous state in case an operation within the transaction fails.</i>
Logging	<ul style="list-style-type: none"> ● <i>Use Log4j for implementing logging</i> ● <i>No sensitive information in logs</i> ● <i>All logged message are time-stamped and tagged with the name of the generating controller</i>
Exception handling	<ul style="list-style-type: none"> ● <i>Retry process for operations where data source errors or timeouts occur</i> ● <i>Exceptions also posted in the Windows Event Logs</i>
Reference table	<ul style="list-style-type: none"> ● <i>Reference table for list of countries that can be maintained</i> ● <i>Use Address Data Infrastructure</i>
Internationalisation	<ul style="list-style-type: none"> ● <i>Support for Hong Kong Chinese Character Set</i>
Sample code artefact	<i>Nil</i>

4.3.1.1.2 Describe each subsystem into components

<Include a diagram to show the components of each subsystems.>

<Class Diagram(s).>

Sample:

Library borrowing record subsystem

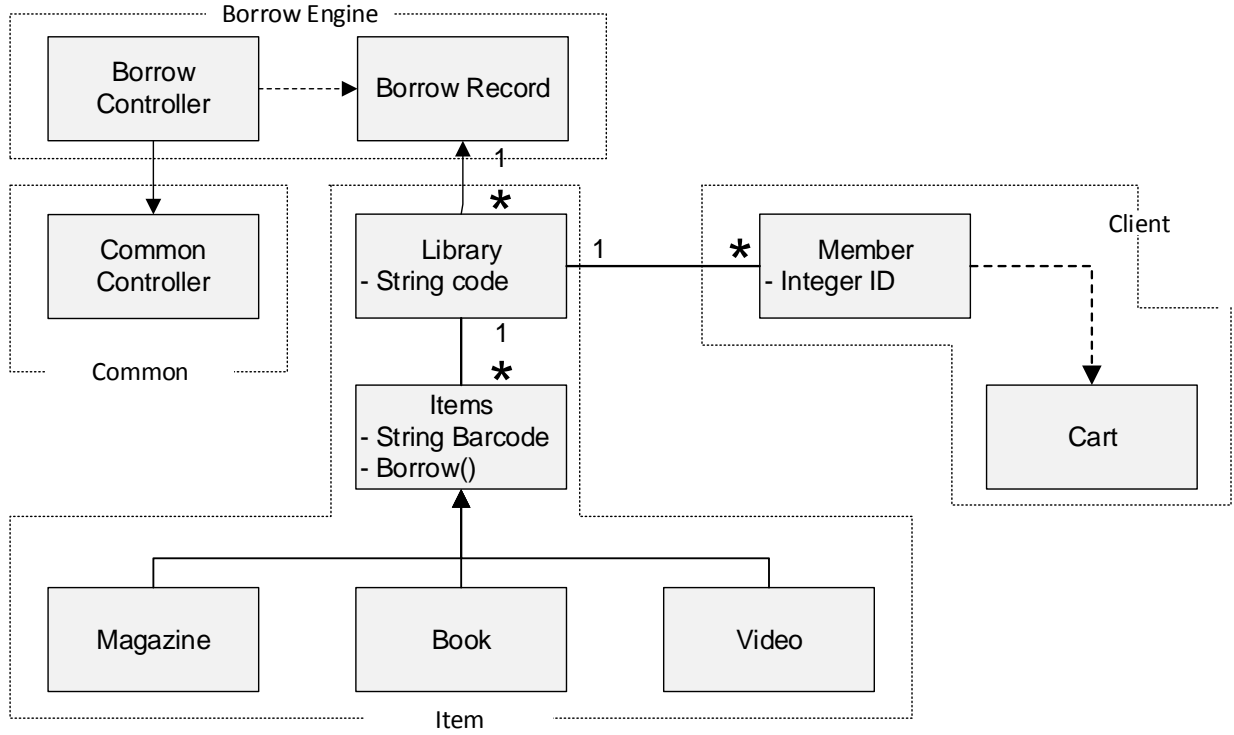

<Include diagrams such as a sequence or activity diagram to identify the internal flow of control between components.>

<Sequence Diagram(s).>

Sample:

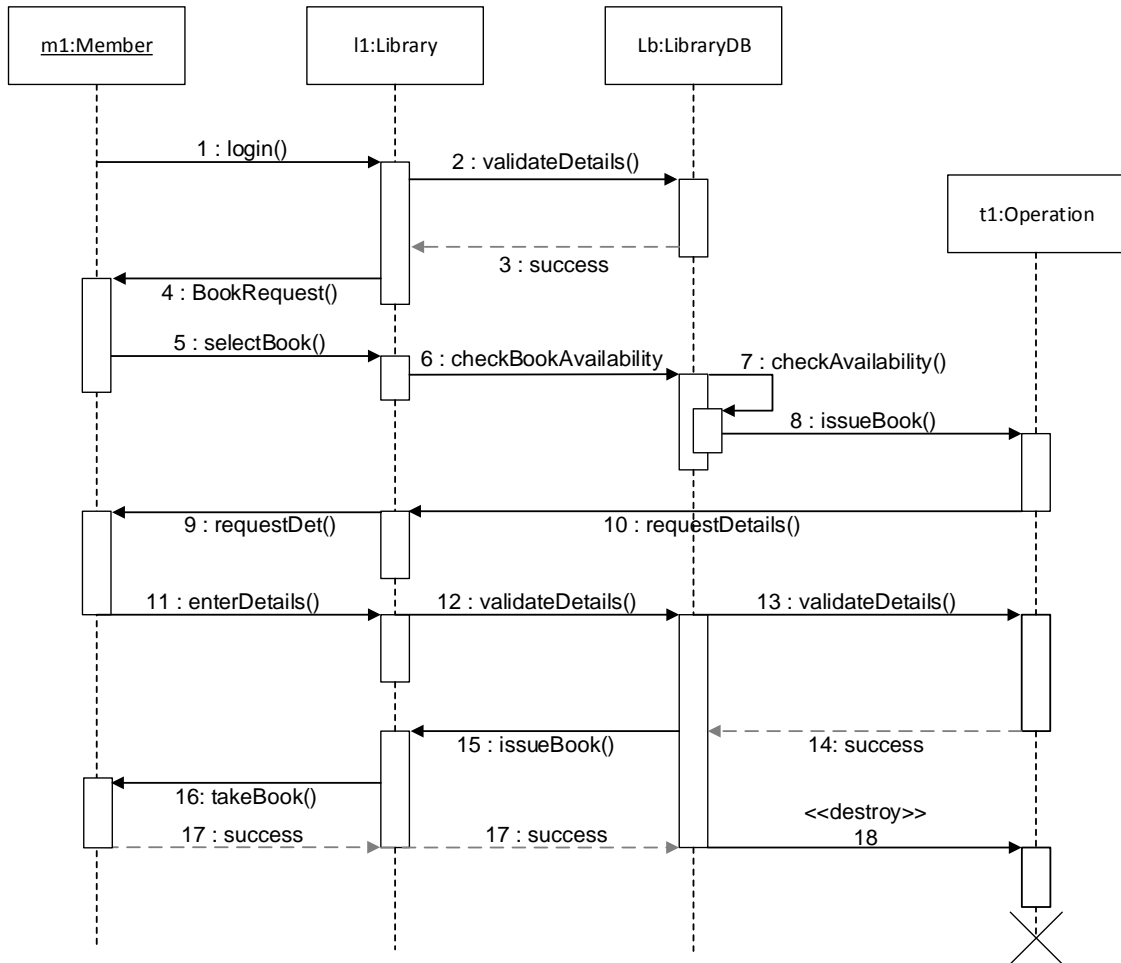

<Activity Diagram(s).>

Sample:

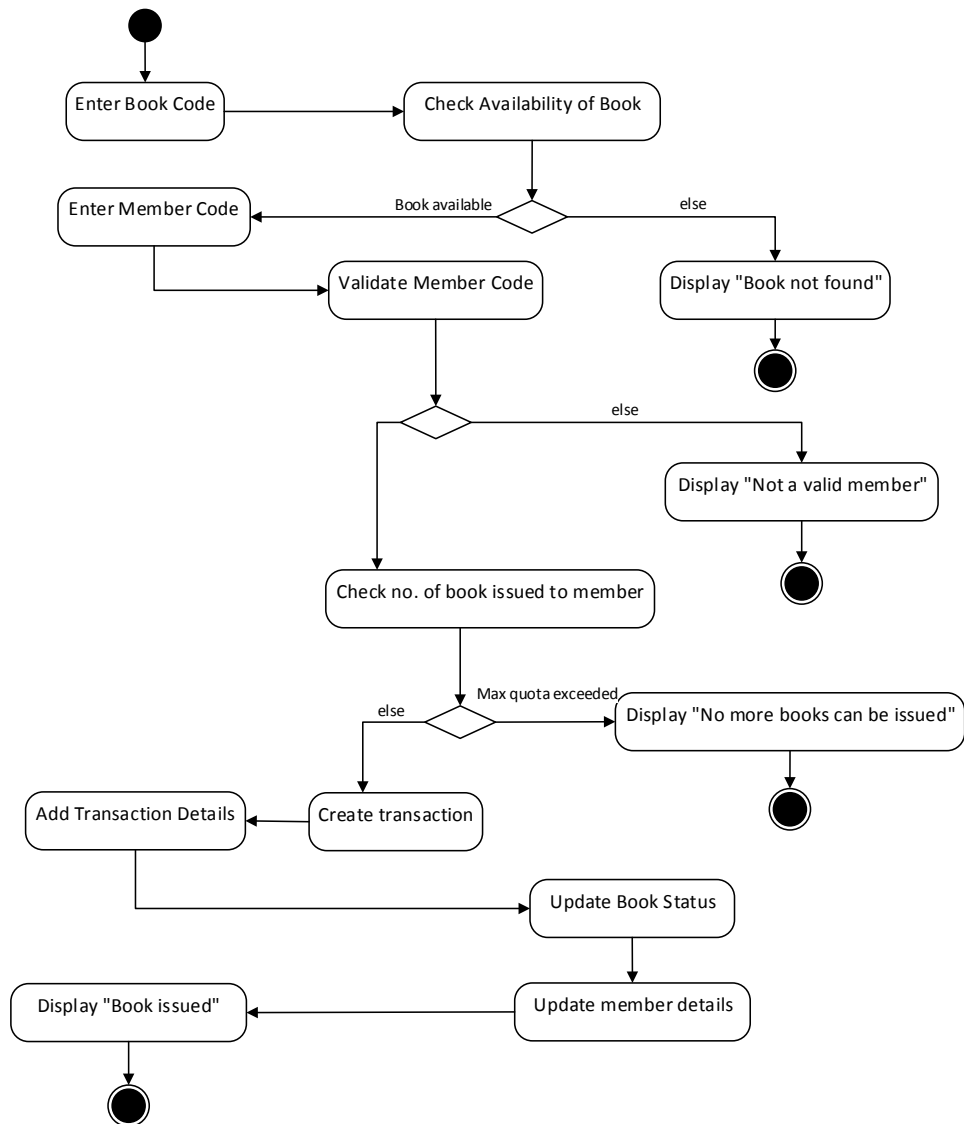

<Include diagrams such as state diagram to describe the behavior of a single object in response to a series of events in a system.>

<State Diagram(s).>

Sample:

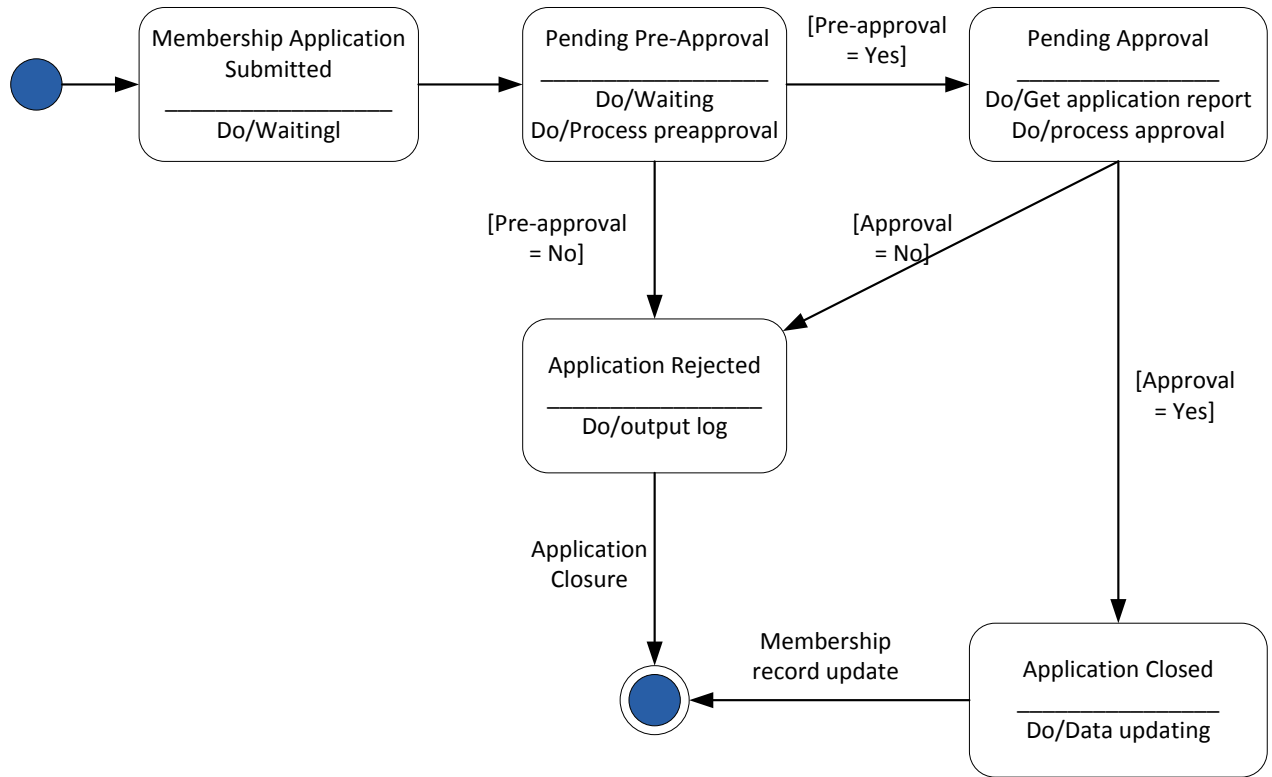

<Describe the design of implementation of business rules.>

<List the business rules and capture their details.>

Business rules description:

Rule#	Rule	Rule Attributes	Rule Conditions	Rule Actions	Rule Priority	Rule Validity	Dependency
<Input number>	<Input name defined>	<Document the attributes and operation performed >	<Describe the conditions that the rule checks >	<Input actions>	<Input the priority of the rule>	<Input the constraints under which the rule is valid >	<Describe the dependency on another rule>
1	Book_issued	User.ID No.Book.Issued	Book.Issued = "Max quota exceeded"	Perform check whether No.Book.Issued =< 3	1	Rule is applicable only after Nov 2014	N/A

4.3.1.2 Design Integration

4.3.1.2.1 <Describe the integration design.>

<Describe the integration flows with each end system, and the type of message integration exposed by the interfaces with the end systems. Include diagrams to show the interfaces.>

Interface Name	Interface Frequency Type	Actors Involved	Context goal	Preconditions	Post conditions
<i><Input the interface name></i>	<i><Input the frequency and schedule for the invocation of the interface ></i>	<i><Document the end systems and any other actor using the interface></i>	<i><Document the functionality performed by the interface></i>	<i><Document any preconditions for the interface></i>	<i><Document any post conditions performed after the interface successfully completes the business functionality></i>
<i>Client interface</i>	<i>On demand</i>	<i>Document management system</i>	<i>The interface fetches all client information when refreshed</i>	<i>N/A</i>	<i>Request log is saved after successful execution</i>

4.3.1.2.2 <Include data mapping and transformation rules.>

Data control description:

<i><Source System> Data Element</i>	<i>Required (Y/N)</i>	<i><Target System> Data Element</i>	<i>Required (Y/N)</i>	<i>Mapping Logic</i>
<i><Input field name></i>	<i><Input></i>	<i><Input field name></i>	<i><Input></i>	<i><Define any mapping rules between the two fields></i>
<i>Author.Name</i>	<i>Y</i>	<i>Author.LastName Author.FirstName</i>	<i>Y</i>	<i>Segregate Author.Name into Author.LastName and Author.FirstName</i>

4.3.1.2.3 <Describe design of integration sub-system.>

<Include diagrams to depict the logic implemented.>

<Provide details on sub process names, input and output fields, and data types. Define details on handling of exceptions, usage of global variables and implementation of logging and security frameworks. Document details on usage of any proprietary Application Programming Interface (API) names or design time libraries, field types, field names, and input/output details that will be used.>

4.3.1.3 Design Data Conversion

<Describe the source data entities, their business services and technical descriptions.>

Source data entity description:

Source	Source Data Entity	Destination	Target Data Entity	Transformation/Cleansing Rules	Notes
<Input source location>	<Input source data entity>	<Input target location>	<Input target data entity>	<Describe data transformation that is to occur>	<Describe any timing constraints or anything unique about the conversion>
<i>CRM</i>	<i>(Old) Client name</i>	<i>New Library System</i>	<i>(New) Client name</i>	<i>Cleanse preceding spaces</i>	<i>N/A</i>

<Describe the expected results of the data conversion process.>

<Describe any business rules that need to be executed during the conversion process.>

Data conversion results:

Source					Target				
Data Entity	Description	Allowable Values	Field Type	Field Length	Cardinality	Mapping Rule	Data Entity	Field Type	Field Length
<Input>	<Input>	<Input>	<Input>	<Input>	<Input>	<Input>	<Input>	<Input>	<Input>
<i>(Old) Client name</i>	<i>Name of Client</i>	<i>Any alphabets</i>	<i>String</i>	<i>50</i>	<i>Mandatory</i>	<i>One-to-one mapping</i>	<i>(New) Client name</i>	<i>String</i>	<i>50</i>

<Document the data conversion tasks that must be carried out in advance or during the conversion runs, and create process flow and data flow diagrams to depict dependencies.>

<Document error handling requirements and include error handling design in process and data flows.>

<Describe design of extraction programs, and conversion, cleansing, and loading programs.>

4.3.1.4 User Experience Design

<Include the UI information architecture such as a site map to provide a top-down view of how the users will interact with various pages, functions, and content and identify the screens or pages that would be developed for the application and their relations.>

<UI information architecture.>

Sample:

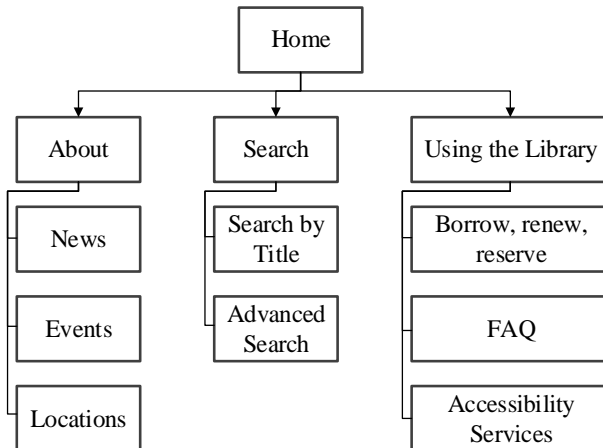

<Describe any implementation guidelines of user interface components, and text copy of any content, error messages, labels, and other static content.>

<For each mock-up, include the picture of the mock-up, and describe the elements presented within the mock-ups, screen actions and messages if applicable.>

<Picture of mock-up.>

Sample:

Borrow book

i

Search results	ISBN	Reserved (Y/N)	Select
Book Title 1	XXXXXX	Y	<input checked="" type="checkbox"/>
Book Title 2	XXXXXX	N	<input type="checkbox"/>
Book Title 3	XXXXXX	N	<input type="checkbox"/>

Elements presented (if applicable):

Field Name in Mock-up	Table Name, Column Name	Data Type	Validation	Comments
<Input>	<Input>	<Input>	<Input>	<Input>
<i>Keyword</i>	<i>N/A</i>	<i>Text</i>	<i>No special characters</i>	<i>N/A</i>

Screen actions (if applicable):

Type	Label	Action	Comments
<Input>	<Input>	<Input>	<Input>
<i>Button</i>	<i>Search</i>	<i>Search the database for matching book titles</i>	<i>N/A</i>

Messages (if applicable):

Message ID	Description	Type	Triggering Event
<Input>	<Input>	<Input>	<Input>
<i>Error1</i>	<i>Display warning when no keyword is entered</i>	<i>Warning</i>	<i>Search</i>

4.3.2 Data Model

<Provide an overview of the content in Data.>

4.3.2.1 Logical Data Model

<Identify all entity types that will have one or more data attributes, such as First Name, Last Name, Middle Initial, and so on.>

Logical data entity description:

Logical Data Entity	Logical Data Entity Description
<i>BORROW RECORD</i>	<p><i>Includes a history record of borrowed book materials, such as written, printed, illustrated, or blank sheets, made of ink, paper, parchment, or other materials, registered to one User during a specific period.</i></p> <p><i>Book title, ISBN and date in/out will be unique of each record</i></p>

<Include a Logical Data Model diagram that depicts the following:

- *Logical Data Entity Groupings – a logical data entity grouping is a collection of logically grouped attributes that are related to one another based on characteristics of those attributes. This may include but is not limited to: people, places, things, and concepts of interest to the business.*
- *Attributes – an attribute is a representation of a single elementary unit of business information.*
- *Relationships – a relationship shows how the logical data entity groupings are related, including cardinality (one-to-one, one-to-many or many-to-many). In relational logical models, many-to-many relationships must be resolved.>*

<Logical data model diagram.>

Sample:

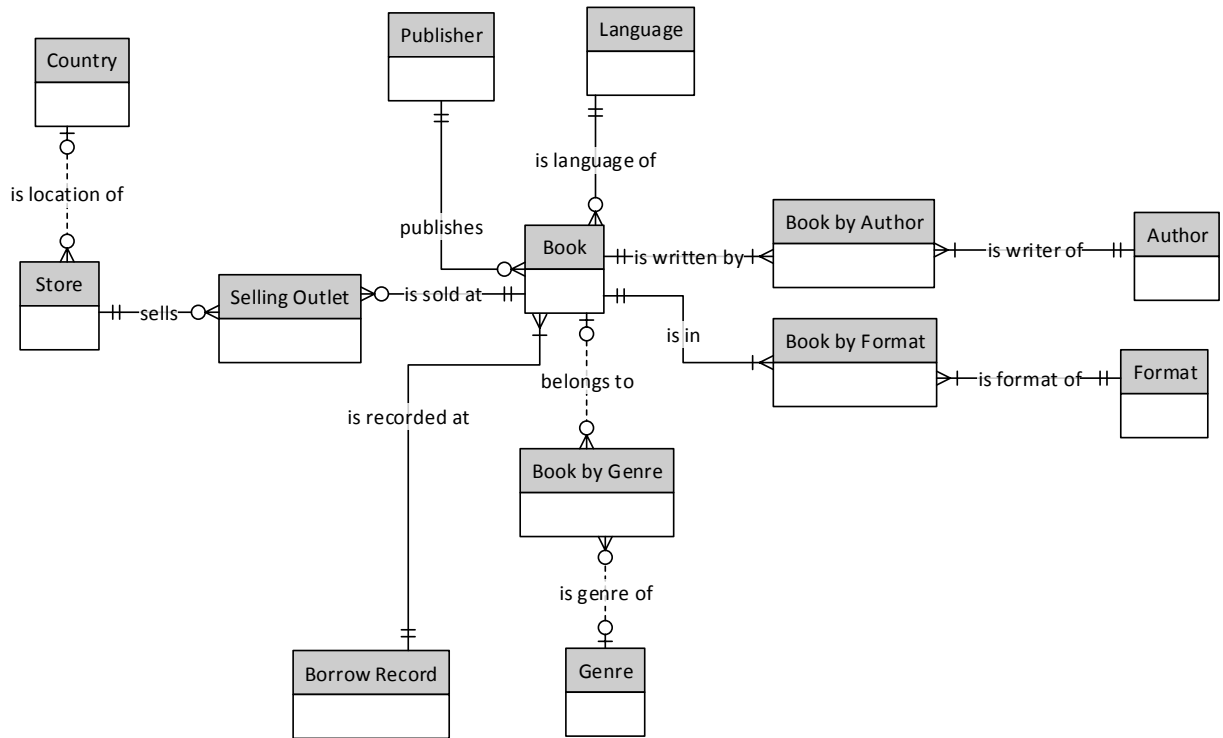

4.3.2.2 Physical Data Model

<Include the details of entities:>

- *Table Name:* provide name of the table
- *Field Name:* provide name of the field
- *Field Format:* define the logical format of the field, e.g. Integer, Char
- *Field Length:* specify name of the field (e.g. Borrow Date)
- *Description:* provide a brief description of the field (e.g. Date book was issued to User)
- *Mandatory:* specify if the field is mandatory
- *Primary Key:* specify whether the field is used as primary key
- *Foreign Key:* specify the field name of another table for foreign key>

Physical data entity description:

Table Name	Field Name	Field Format	Field Length	Description	Mandatory	Primary Key	Foreign Key
<Input>	<Input>	<Input>	<Input>	<Input>	<Input Y/N>	<Input Y/N>	<Input>
BORROW RECORD	RECORD_ID	VARCHAR	1000	Borrow Record ID	Y	N	N/A

<Include a physical data model diagram.>

<Physical data model diagram.>

Sample:

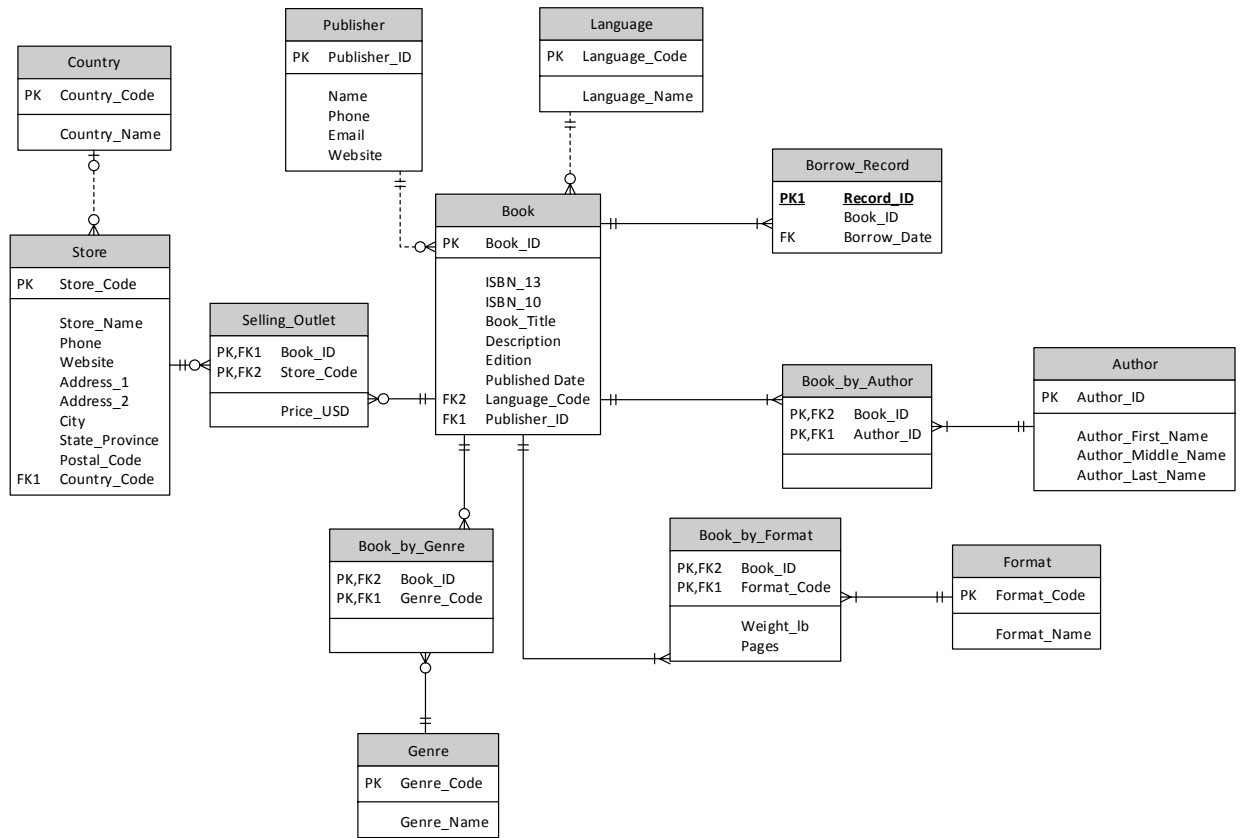

5 TECHNICAL SYSTEM OPTION

5.1 TECHNICAL SYSTEM ARCHITECTURE

<Provide an overview of the hardware and hosting platforms, network architecture and storage architecture.>

<Describe the backup, restore and archiving solution for network, storage and platform architectures.>

5.1.1 Network Architecture

<Describe the linkages and connections between different physical nodes. Describe each environment.>

<Include the network diagram(s).>

<Network diagram(s).>

Sample:

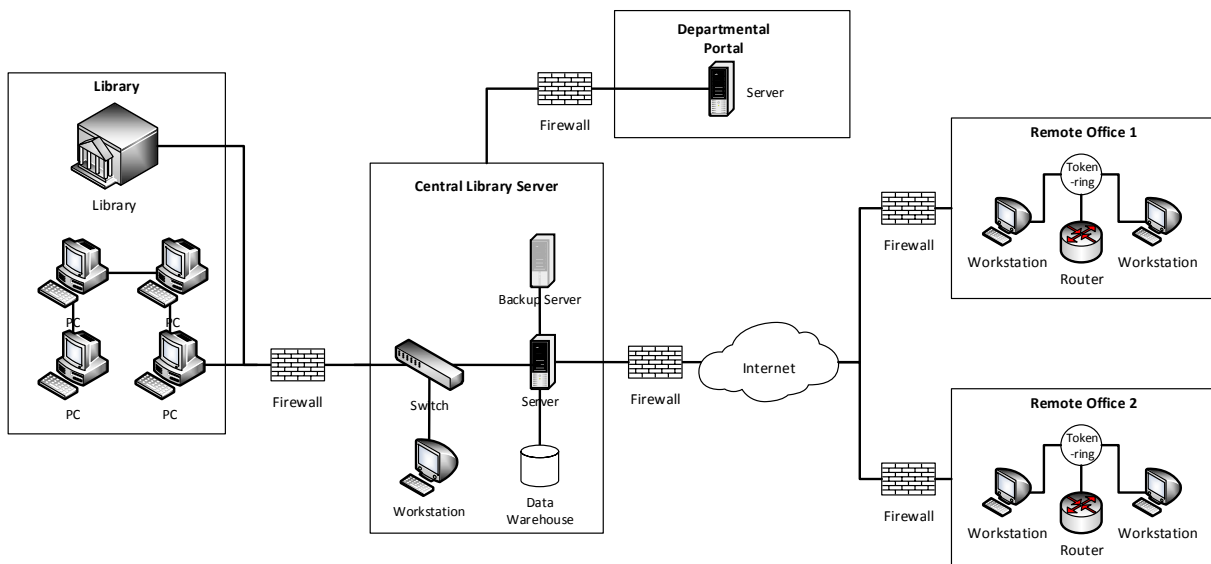

<Describe the configuration for physical nodes.>

5.1.2 Storage Architecture

<Describe the storage architecture that will support the applications and systems, describes how data are protected, replicated, and persisted.>

<Include the data storage diagram(s).>

<Data storage diagram(s).>

Sample:

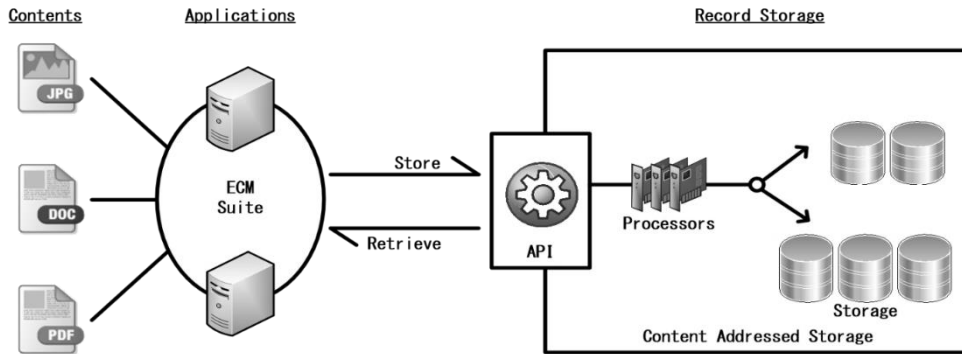

5.1.3 Platform Architecture

<Describe the hosting services in client computing and data centre design.>

<List and describe each environment.>

Environment description:

Environment	Machine	Hardware	Description	Software	Quantity
<Input name of environment>	<Input name of machine>	<Input hardware>	<Input description>	<Input software>	<Input quantity for the machine>
<i>Production</i>	<i>App_Svr_XX</i>	<i>X6210</i>	<i>Application Server</i>	<i>Windows Server 2012 Tomcat 8</i>	<i>2</i>

<Describe the system configurations.>

5.2 SIZING MODEL

<Depending on the platform, include the sizing model for the following typical items:

- Data Storage
- Transaction Rate
- Data Access
- Server Sizing
- Network Sizing.>

Sample:

<This is just a sample model and is by no means the required way to conduct sizing estimation. The following are the assumptions that will be applied to all sizing calculations in this sample.>

- All functions in the system had been considered in the sizing analysis.
- The sizing model will cater for the projected 2-year growth of the system.
- 1 day = 8 working hours; 1 month = 30 working days.
- Transaction volume for Year 0 is determined based on that of existing system.

Data Storage

- Sizing is conducted based on the following information defined
 - Record Length of each data entity
 - Number of Records of each data entity
 - Annual Growth Rate of each data entity
 - Key Length of each data entity
 - Number of Keys of each data entity
- Database storage size is calculated by:
 - Determining the data Packing Density, which is the storage overhead factor
 - A Packing Density of 0.8, which implies a 20% storage overhead
 - Calculating the Raw Data Storage of year 0 (i.e., the first year when the system goes live) using the following formula:
 - $Raw\ Data\ Storage\ (MB) = Record\ Length * No.\ of\ Records\ of\ Year\ 0 / Packing\ Density / 1024 / 1024$
 - Calculating the Raw Data Storage of subsequent years using the following formula:
 - $Y_n = Y_{n-1} \times (1 + g)$
 - Where Y_n is the Raw Data Storage of year n and g is the Annual Growth Rate

Raw Data Storage

Entity Name	Annual Growth Rate (%)	Record Length (byte)	No. of Records	Record Storage (MB)		
				Yr 0	Yr 1	Yr 2
<i>LIBRARIAN</i>	<i>10.00%</i>	<i>150</i>	<i>1,708</i>	<i>0.31</i>	<i>0.34</i>	<i>0.37</i>
<i>BOOK</i>	<i>4.00%</i>	<i>2,270</i>	<i>18,678,660</i>	<i>50,545</i>	<i>52567</i>	<i>55195</i>

- Calculating the Index Storage of year 0 (i.e., the first year when the system goes live) using the following formula:
 - $Index\ Storage\ (MB) = (Key\ Length + 8 * No.\ of\ Keys) * No.\ of\ Records / Packing\ Density / 1024 / 1024$
- Calculating the Index Storage of subsequent years using the following formula:
 - $I_n = I_{n-1} \times (1 + g)$
 - Where I_n is the Index Storage of year n and g is the Annual Growth Rate

Index Storage

Entity Name	Annual Growth Rate (%)	No. of Records	Index Length (byte)	No. of Keys	Record Storage (MB)		
					Yr 0	Yr 1	Yr 2
<i>LIBRARIAN</i>	<i>10.00%</i>	<i>1,708</i>	<i>8</i>	<i>1</i>	<i>0.033</i>	<i>0.036</i>	<i>0.039</i>
<i>BOOK</i>	<i>4.00%</i>	<i>18,678,660</i>	<i>35</i>	<i>1</i>	<i>957.47</i>	<i>995.77</i>	<i>1,035.60</i>

- *The Total Database Storage size is:*
 - *Total Database Storage (MB) = Raw Data Storage of Year N + Index Storage of Year N. Year N is the last year the system is in use*

Transaction Rate

- *Sizing is conducted based on the following information*
 - *Transaction volume of each function*
 - *Annual growth rate of each function*
- *Transaction volume is calculated by*
 - *Determining the Peak-Loading factor*
 - *A Peak-Loading factor of 1.5, which assumes an extra 50% loading during the peak hour*
 - *Calculating the Hourly Peak Transaction Rate of year 0 (i.e., the first year when the system goes live) using the following formula:*
 - *Hourly Peak Transaction Rate = (Transaction Volume of Year 0) / ((Monthly Working Days) × (12 months) × (Daily Working Hours)) × (Peak-hour Loading Factor)*
 - *Calculating the Hourly Peak Transaction Rate of subsequent years using the following formula:*
 - *$TR_n = TR_{n-1} \times (1 + g)$*
 - *Where TR_n is the Hourly Peak Transaction Rate of year n and g is the Annual Growth Rate*

Function ID	Function Name	Transaction Volume of Year 0	Annual Growth Rate (%)	Mode	Transaction Rate (Hourly Peak)		
					Yr 0	Yr 1	Yr 2
<i>1</i>	<i>Search book</i>	<i>188,817,811</i>	<i>5%</i>	<i>Online</i>	<i>98,342.61</i>	<i>103,259.74</i>	<i>108,422.73</i>
<i>2</i>	<i>Create new book</i>	<i>4,620,691</i>	<i>5%</i>	<i>Online</i>	<i>2,406.61</i>	<i>2,526.94</i>	<i>2,653.28</i>

Data Access

- *Data access is calculated using the following information:*
 - *For each function, the data entities in which it will access as well as the access type are determined, i.e., Retrieval [R], Update [U], Insertion [C] or Deletion [D]*
 - *The data access rate is calculated:*
 - *Data Access Rate = Average Number of Records Accessed * Hourly Peak Transaction Rate*
 - *Calculate the tpm-C (transaction per minute – Benchmark C): (The benchmark C adopted by the Transaction Processing Performance Council is being referenced)*
 - ◆ *$tpm-C = Total\ Data\ Access\ Rate \times Hourly\ Peak\ Transaction\ Rate / 60$ where Total Data Access Rate is the sum of number of records accessed of all related data entities of the transaction*

ID	Function Name	Entities	Access Type	Avg. No. of Records Accessed	Yr 2 Transaction Rate (Hourly Peak)	Retrieve	Update	Insert	Delete
<i>3</i>	<i>Login</i>	<i>AUDITLOG</i>	<i>C</i>	<i>1</i>	<i>5.10</i>	<i>0.00</i>	<i>0.00</i>	<i>5.10</i>	<i>0.00</i>
		<i>USER</i>	<i>C</i>	<i>1</i>	<i>5.10</i>	<i>0.00</i>	<i>0.00</i>	<i>5.10</i>	<i>0.00</i>
<i>4</i>	<i>Logout</i>	<i>AUDITLOG</i>	<i>C</i>	<i>1</i>	<i>15.30</i>	<i>0.00</i>	<i>0.00</i>	<i>15.30</i>	<i>0.00</i>
		<i>USER</i>	<i>U</i>	<i>1</i>	<i>15.30</i>	<i>0.00</i>	<i>15.30</i>	<i>0.00</i>	<i>0.00</i>

Server Sizing

- For each server within the system (e.g. web, application, database, content management server), the following sizing is determined based on previous project, vendor specifications, and/or other calculation methods:
 - CPU sizing
 - Memory sizing
 - Internal disk storage sizing

External Web Server:

CPU: Based on vendor recommendations, Intel Octa-Core Xeon CPU is selected.

Memory:

<i>External Web Server</i>			
<i>Component</i>		<i>Description</i>	<i>(GB)</i>
<i>1</i>	<i>Operating System Software</i>		<i>8</i>
<i>2</i>	<i>Application Software (Web Server)</i>		<i>4</i>
<i>3</i>	<i>Other Software</i>		
	<i>- Monitoring & Housekeeping Tools</i>	<i>20% of [(1) + (2)]</i>	<i>2.4</i>
<i>4</i>	<i>Data Buffer</i>	<i>50% of [(1) + (2) + (3)]</i>	<i>7.2</i>
<i>5</i>	<i>Sub-total</i>		<i>21.6</i>
<i>6</i>	<i>System Buffer Cache</i>	<i>10% of (5)</i>	<i>2.16</i>
<i>Total</i>			<i>23.76</i>
<i>Recommended Memory (GB)</i>			<i>24</i>

Internal Disk Storage:

<i>External Web Server</i>			
<i>Component</i>		<i>Description</i>	<i>(GB)</i>
<i>1</i>	<i>Operating System</i>		<i>60</i>
<i>2</i>	<i>Swap Space</i>	<i>2 x Physical Memory Size</i>	<i>48</i>
<i>3</i>	<i>Crash Dump Area</i>	<i>1 x Physical Memory Size</i>	<i>24</i>
<i>4</i>	<i>Application Server Software</i>		<i>5</i>
<i>5</i>	<i>Working Space</i>	<i>4 x (4)</i>	<i>20</i>
<i>6</i>	<i>Other Application Programs</i>		<i>0</i>
<i>7</i>	<i>Application Server Log</i>		<i>5</i>
<i>8</i>	<i>Sub-total</i>		<i>162</i>
<i>9</i>	<i>Contingency</i>	<i>20% of (8)</i>	<i>32</i>
<i>Total</i>			<i>194</i>
<i>Recommended Storage (GB)</i>			<i>200</i>

Network Sizing

- Network sizing is conducted based on the followings:
 - For each access point, The following information is used to determine the requirement:
 - The number of concurrent users during the peak hour
 - The average bandwidth requirement for each user

The bandwidth requirement between the Production Site and the Internet:

<i>Production Site to Internet</i>			
<i>Description</i>	<i>Breakdown</i>	<i>Mbps</i>	<i>Remark</i>
<i>Internet concurrent library system users (a)</i>	<i>200</i>		
<i>Bandwidth requirement per library system user in Kbps (b)</i>	<i>200</i>		
<i>Bandwidth requirement for all Internet library system users (c)</i>		<i>40</i>	<i>(c) = (a) x (b) / 1000</i>
	<i>Subtotal (d)</i>	<i>40</i>	
	<i>Protocol overhead (e)</i>	<i>8</i>	<i>(d) x 20%</i>
	<i>Contingency (f)</i>	<i>4</i>	<i>(d) x 10%</i>
	<i>Total</i>	<i>52</i>	<i>(d) + (e) + (f)</i>

	<i>Recommended Bandwidth (Mbps)</i>	60	
--	-------------------------------------	----	--

5.3 COST / BENEFIT EVALUATION

<Include the cost / benefit evaluation for Technical System Option results.>

<Cost / benefit evaluation results.>

Sample:

Values are in HKD dollars in thousands ('000) unless otherwise indicated

Legend:

Costs and Savings Descriptions	5 year costs and savings projections					
Beginning of:	Year 1.0	Year 2.0	Year 3.0	Year 4.0	Year 5.0	5-Year Total
Costs						
Non-recurrent Expenditure						
(a) Hardware	6,360.7	12,819.5	16,251.5	21,436.1	6,533.1	63,400.9
(b) Software	12,702.0	32,322.0	22,190.9	12,073.8	72.4	79,361.2
(c) Implementation Services	19,189.3	44,850.7	51,139.1	52,120.2	21,737.1	189,036.4
(d) Contract Staff	0.0	0.0	0.0	0.0	0.0	0.0
(e) Site Preparation	6,133.3	2,143.9	11,690.7	21,444.7	8,031.2	49,443.9
(f) Communication Lines	3,251.0	0.0	0.0	0.0	0.0	3,251.0
(g) Training Cost	166.7	2,270.8	2,600.0	2,537.5	600.0	8,175.0
(h) Contingency	4,780.3	9,440.7	10,387.2	10,961.2	3,697.4	39,266.8
Sub-total	52,583.3	103,847.6	114,259.6	120,573.6	40,671.2	431,935.3
Non-recurrent Staff						
Sub-total	16,265.6	19,073.9	22,110.0	19,601.4	6,529.6	83,580.4
Total non-recurrent cost	68,848.9	122,921.5	136,369.6	140,175.0	47,200.8	515,515.7
Recurrent Expenditure						
Sub-total	0.0	0.0	0.0	4,574.2	17,693.1	22,267.3
(a) Hardware and Software Maintenance	0.0	0.0	0.0	4,574.2	17,693.1	22,267.3
(b) On-going System Support Services	167.0	648.8	1,257.3	3,964.6	7,061.9	13,099.6
(c) Communication Lines	0.0	11,736.0	11,736.0	11,736.0	11,736.0	46,944.0
(d) Consumable	10.0	35.0	1,455.0	2,470.0	2,090.0	6,060.0
Sub-total	177.0	12,419.8	14,448.3	22,744.8	38,581.0	88,370.9
Recurrent Staff						
Sub-total	5,840.2	7,291.4	9,123.9	19,220.4	30,263.5	71,739.4
Total recurrent cost	6,017.2	19,711.2	23,572.2	41,965.2	68,844.5	160,110.3
Total cost	74,866.1	142,632.7	159,941.7	182,140.2	116,045.3	675,626.0
Saving						
Non-recurrent						
Sub-total	4,432.5	4,432.5	0.0	0.0	0.0	8,865.0
Cost avoidance	4,432.5	4,432.5	0.0	0.0	0.0	8,865.0
Recurrent						
Sub-total	0.0	0.0	5,057.9	7,309.2	10,622.3	22,989.4
Realisable savings	0.0	0.0	5,057.9	7,309.2	10,622.3	22,989.4
Notional savings	0.0	1,539.6	3,832.6	11,621.7	46,758.7	63,752.5
Cost avoidance	0.0	0.0	0.0	0.0	0.0	0.0
Sub-total	0.0	1,539.6	8,890.5	18,930.9	57,381.0	86,741.9
Total saving	4,432.5	5,972.1	8,890.5	18,930.9	57,381.0	95,606.9
Net saving	(70,433.6)	(136,660.6)	(151,051.3)	(163,209.3)	(58,664.2)	(580,019.0)
Net cumulative saving	(70,433.6)	(207,094.2)	(358,145.5)	(521,354.8)	(580,019.0)	762.4

5.4 IMPACT ANALYSIS

<Include the following subsections:

- *Summary on system change/enhancement*
 - *Provide a summary of system changes/ enhancements.*
- *Effect on organisation and staffing levels*
 - *For each recommended initiative (as stated in the section above), highlight the impact they may cause on the respective aspects.*
- *Significant changes in user operating procedures*
 - *From Users' perspective, highlight operational changes and potential challenges they may face.*
- *Implementation considerations*
 - *Elaborate on the impact the system may have on the organisation, and measures to resolve the mentioned issues. Implementation considerations range from training to effects on inexperienced staff at service level.*
- *Savings on replaced equipment and associated costs*
 - *A set of estimated calculations on savings that may be achieved through replacing existing system/ equipment and associated costs.*
- *Risk Analysis*
 - *List out a preliminary set of foreseeable risks in terms of Project Management, Staffing and Resources and Change Management from implementing and introducing the proposed system.>*

Sample:

Summary on system change/enhancement

Current State – because of the decentralised nature of the library system, any in-depth functional collaboration across systems would be impractical, as users would need to access different systems for library-specific data

Future State Recommendation – after implementing a library system, content search can be done across systems more effectively and would further enhance user experience

Effect on organisation and staffing levels

Organisation Level

The overall operational efficiency will be maximised throughout all libraries with the implementation of the library system. Implementation of the new system will result in a shift of staff responsibilities to minimise the effort on repetitive tasks, and instead focus on processes that will increase the overall operational efficiency among all the libraries. Modifications in tasks include the reduced need for library staff to manually input stocktaking data.

Staffing Level

The library system will reduce the need for the library staff to perform repetitive manual work, therefore, resulting in a shift of staff responsibility from performing repetitive data entry work to execute high-skilled knowledge-based tasks such as monitoring procedural workflows and validating business process exceptions.

Significant changes in user operating procedures

Operating procedures and workflows will be modified with the implementation of the new library system. Business operating procedures and workflows will be standardised and follow international

best practices. System functionalities will be aligned with the standardised operating procedures and workflows. In addition, the library system provides automation of the approval process, thus increasing the overall business efficiency. Furthermore, the library's official website (available for public access) will be enhanced to enable fast and effective searches of collection information and provide an improved customer service experience. In general, the following user operating procedures would be affected:

- *Stocktaking list can be generated through the library system and the stocktake record will be stored in the system. Users can have a holistic view of the stocktaking cycle, process and status.*
- *Implementation of tracking technology will increase stocktaking efficiency by allowing staff to access the status and location of collection items stored in the library system more easily. Although manual inspection of the object condition is still required during stocktaking, tracking technology reduces the time needed for repetitive stocktaking tasks, including manual inputting stock counts and object locations*

Implementation considerations

In addition to the identified impacts that will result from the deployment of the new systems, the transitional implementation period will also bring about business changes. A significant amount of the library staffs' effort and time will be required to facilitate the implementation of the new systems.

Change Management

- *Prior to system deployment, UAT is required to assess if the functions developed within the library system fulfil and work as specified within the Functional Specification document. Experienced library staff is required to participate in the UAT and test the functions to make sure the functions work as specified.*
- *Furthermore, library staff is required to attend the training sessions on how to use the library system to perform their daily tasks, as part of the transition between the legacy systems to the new library system.*
- *Resulting Impact:*
 - *Due to the additional effort, the library staff will have less time in performing their normal daily operational tasks.*
- *Recommended Solution:*
 - *It is recommended to hire additional contract staff to maintain the daily operational tasks. The related costs are estimated in the Cost Benefit Evaluation document.*

Data Migration

Vendors will need to leverage library staff's knowledge in order to successfully complete the data migration process, i.e., certain data will require library staff's knowledge to determine how they could be migrated.

- *Resulting Impact:*
 - *Due to the additional effort, the library staff will have less time in performing their normal daily operational tasks.*
- *Recommended Solution:*
 - *It is recommended to hire additional contract staff to maintain the daily operational tasks. The related costs are estimated in the cost / benefit analysis.*

Risk Analysis

With extensive changes required in implementing the library system, there are certain risks involved in completing the project. To ensure success in the system implementation, potential risks and the associated mitigation solutions are identified.

Change Management

Change Management for the future library system describes the transitional measures taken to ensure a successful and smooth transition to the new system.

- *Potential Risks:*
 - *A significant risk of change management includes the ineffective transition from the current*

library systems to the future library system. If change management is not properly performed, the resulting effect could be a disruption to the day-to-day library operations.

- **Recommended Solution:**
 - *Due to significant amount of library operations and staff that will be affected by the change, significant preparation and careful execution will be required to ensure a successful transition. It is recommended that a comprehensive change management plan has to be developed to ensure successful completion within the chosen specified period. In addition, it is recommended that a proper and effective communication channel between all the stakeholders has to be set up.*
- **Data Migration**
 - *Data Migration for the future library system describes the process of actually migrating the data from the existing library systems to the future library system based on the rules and logic defined.*
- **Potential Risks:**
 - *Data migration from 8 separate library systems is a complex and tedious task. A significant risk of data migration includes inconsistency and incorrectness of data being migrated to the centralised library systems. Furthermore, the unsuccessful completion of the task within the proposed 9 month period could delay the overall schedule of the project.*
- **Recommended Solution:**
 - *To ensure the success of data migration, it is recommended that a set of agreed standards and procedures has to be developed prior to the start of the task to minimise the potential risks. In addition, library staff can support the process by offering information and knowledge regarding details of the library data. Leveraging the library staffs' knowledge will help decrease the time needed to understand the data content. In addition, sufficient resources should be allocated to perform the data migration exercise.*

5.5 IMPLEMENTATION PLAN

<Include the following subsections:

- *Implementation Strategy*
 - *Describes the implementation approach that will be adopted during the implementation of the proposed system, based on a desire to minimise dependencies or interfacing requirements, cost and organisational change.*
 - *It highlights the key considerations and assumptions on which the strategy is based on.*
- *Implementation Schedule*
 - *Implementation Timeline of the proposed system should take the following activities into account and add appropriate buffer:*
 - *Requirements*
 - *Analysis and Design*
 - *Development*
 - *Testing*
 - *Deployment*
 - *Documentation*
 - *Meetings and Review*
- *Activities*
 - *Describe each of the activities identified in detail. The document should also highlight contingency plan for critical applications.>*

<Gantt Chart Diagram.>

Sample:

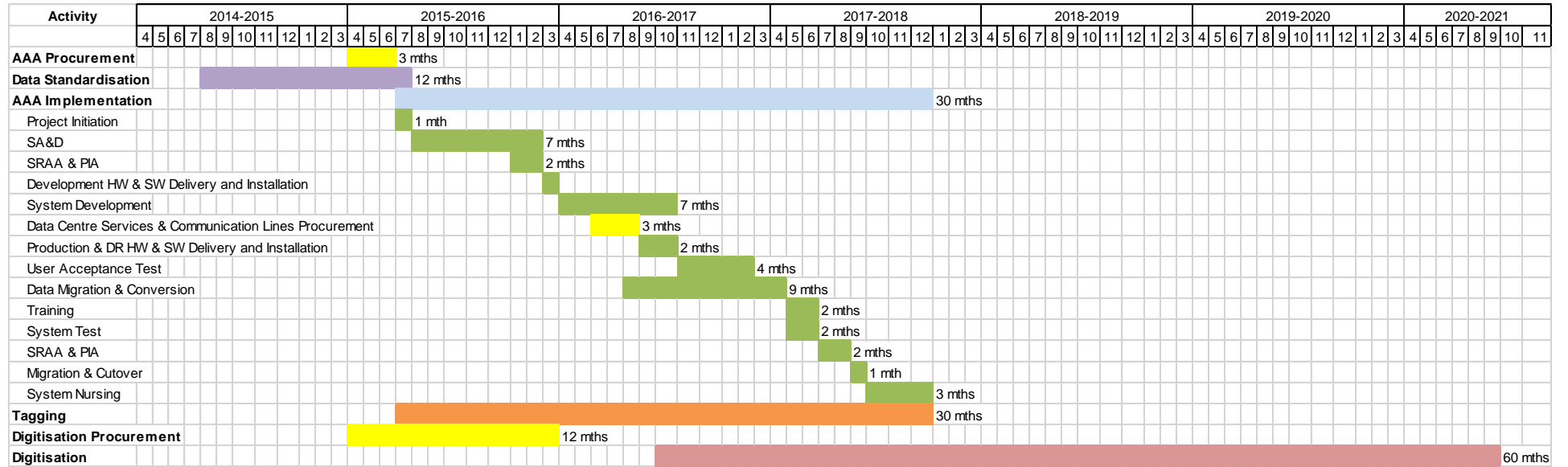

Key

<i>AAA</i>	<i>System Name</i>
<i>SRAA</i>	<i>Security Risk Assessment and Audit</i>
<i>PIA</i>	<i>Privacy Impact Assessment</i>
<i>HW</i>	<i>Hardware</i>
<i>SW</i>	<i>Software</i>
<i>DR</i>	<i>Disaster Recovery</i>